	

4

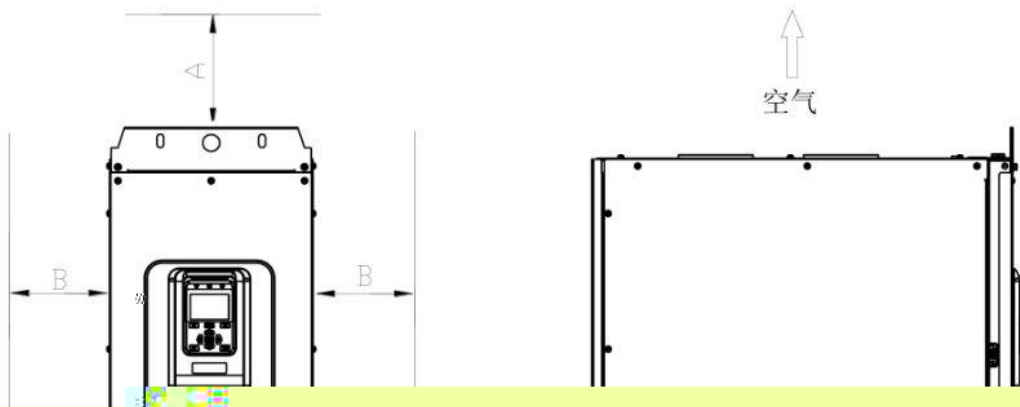



1

2

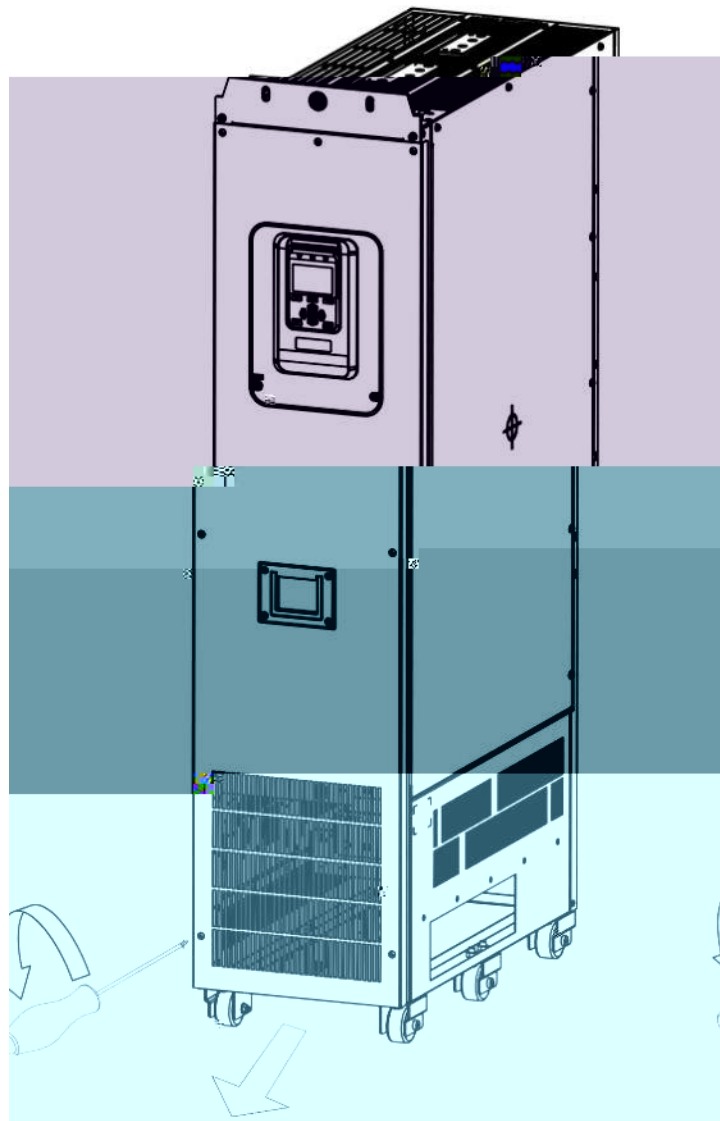



1.

2.

3.

P N R S T PE

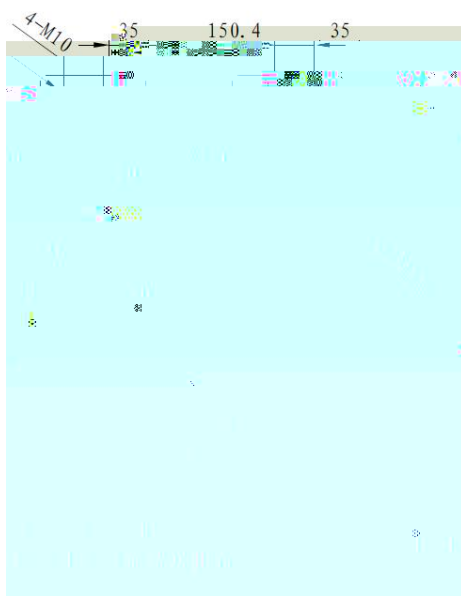

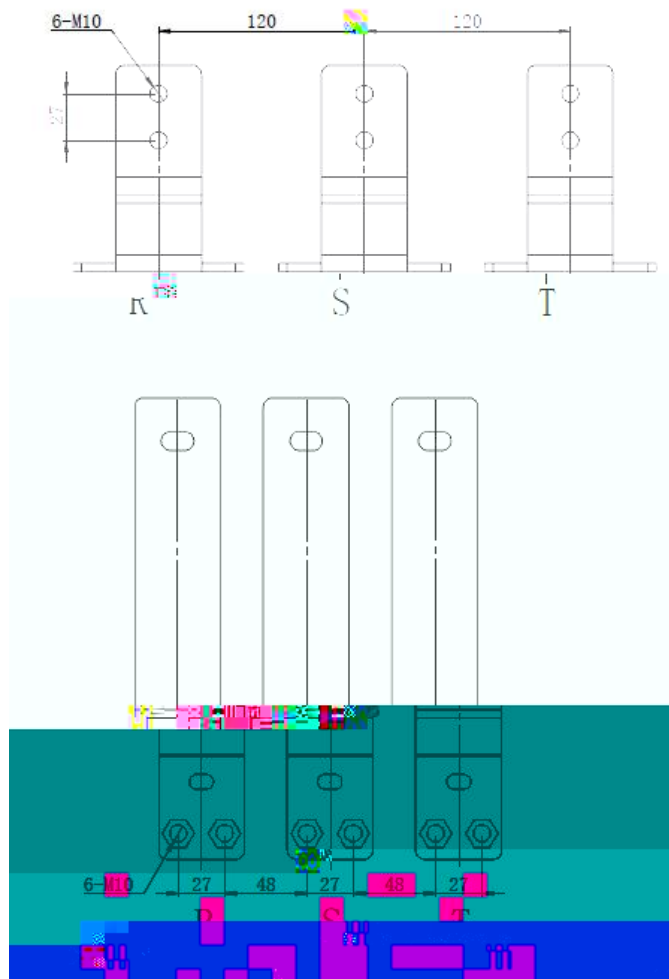
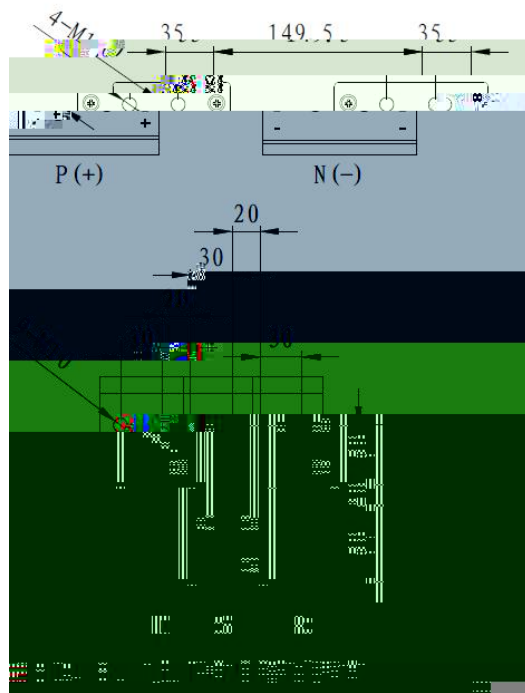





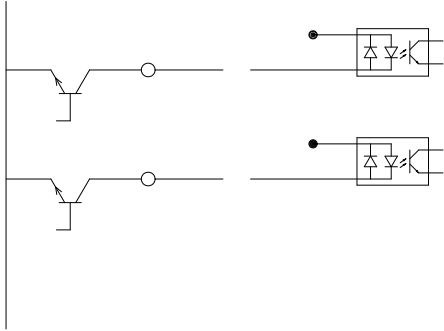

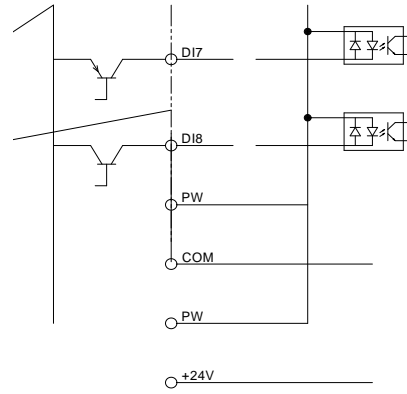
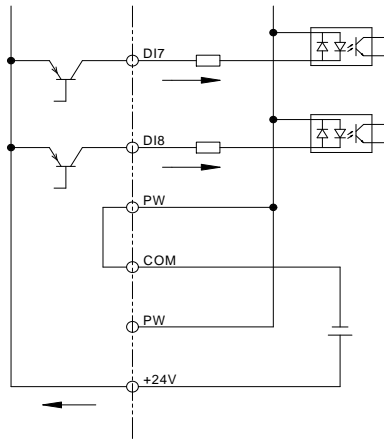

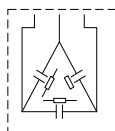

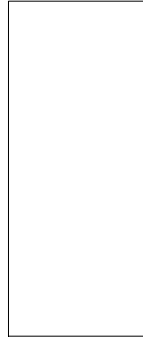
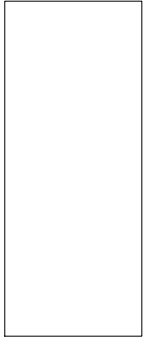



X2a,X3a

X1

X2b,X3b

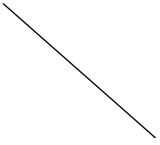

P | N | U | V | W | PF

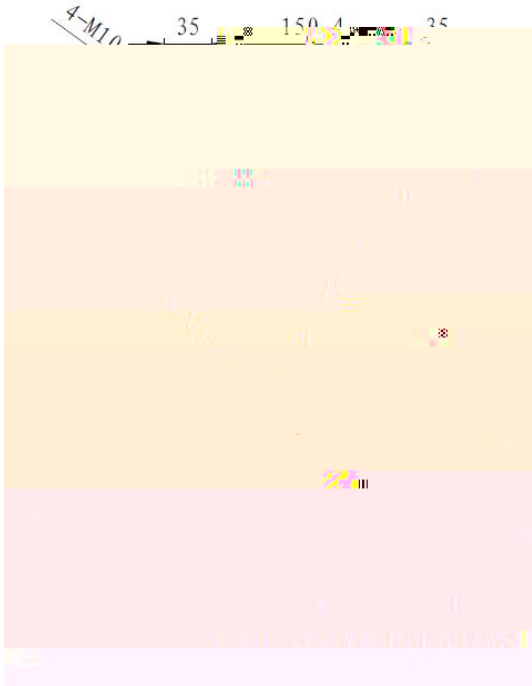

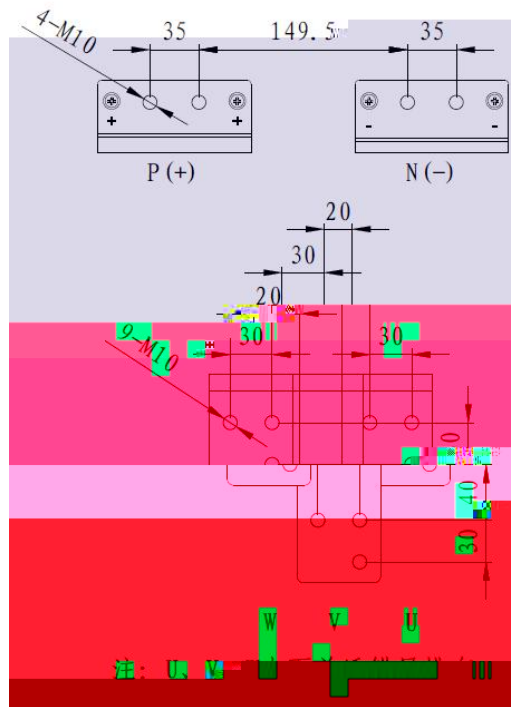

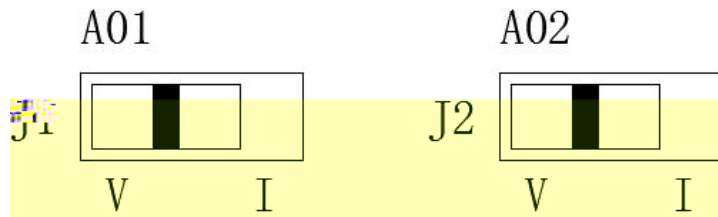
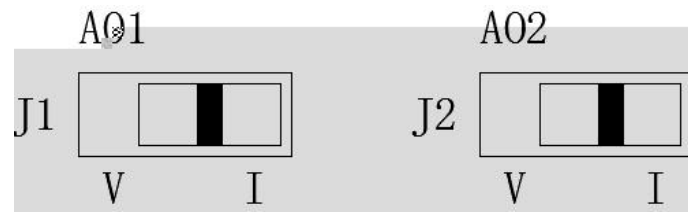



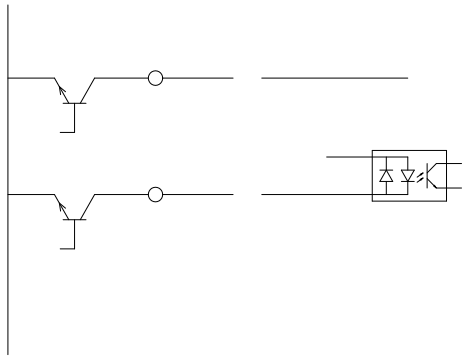



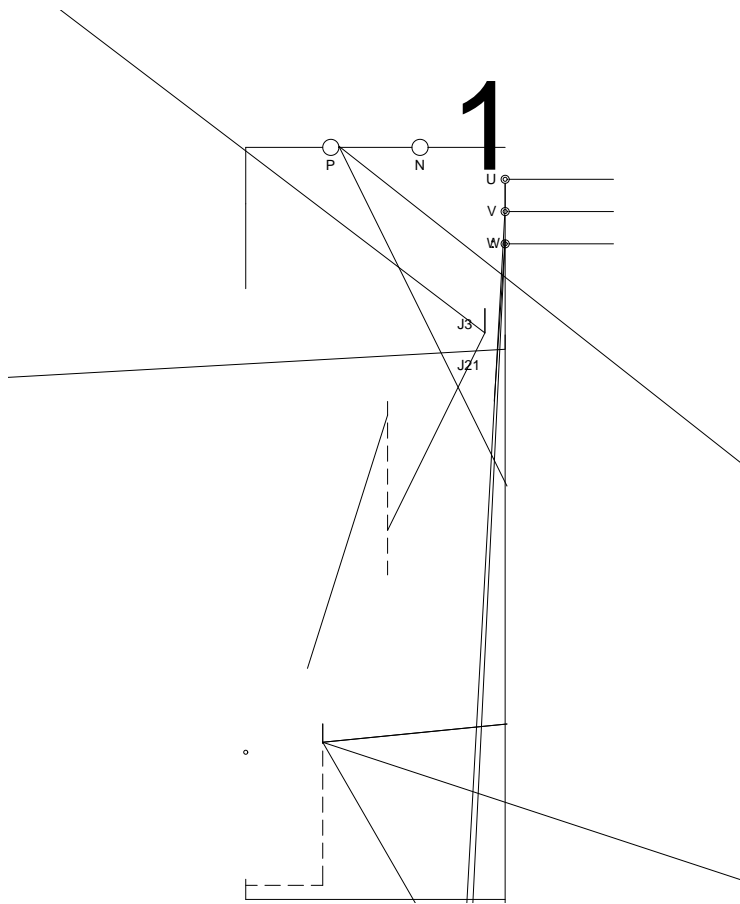

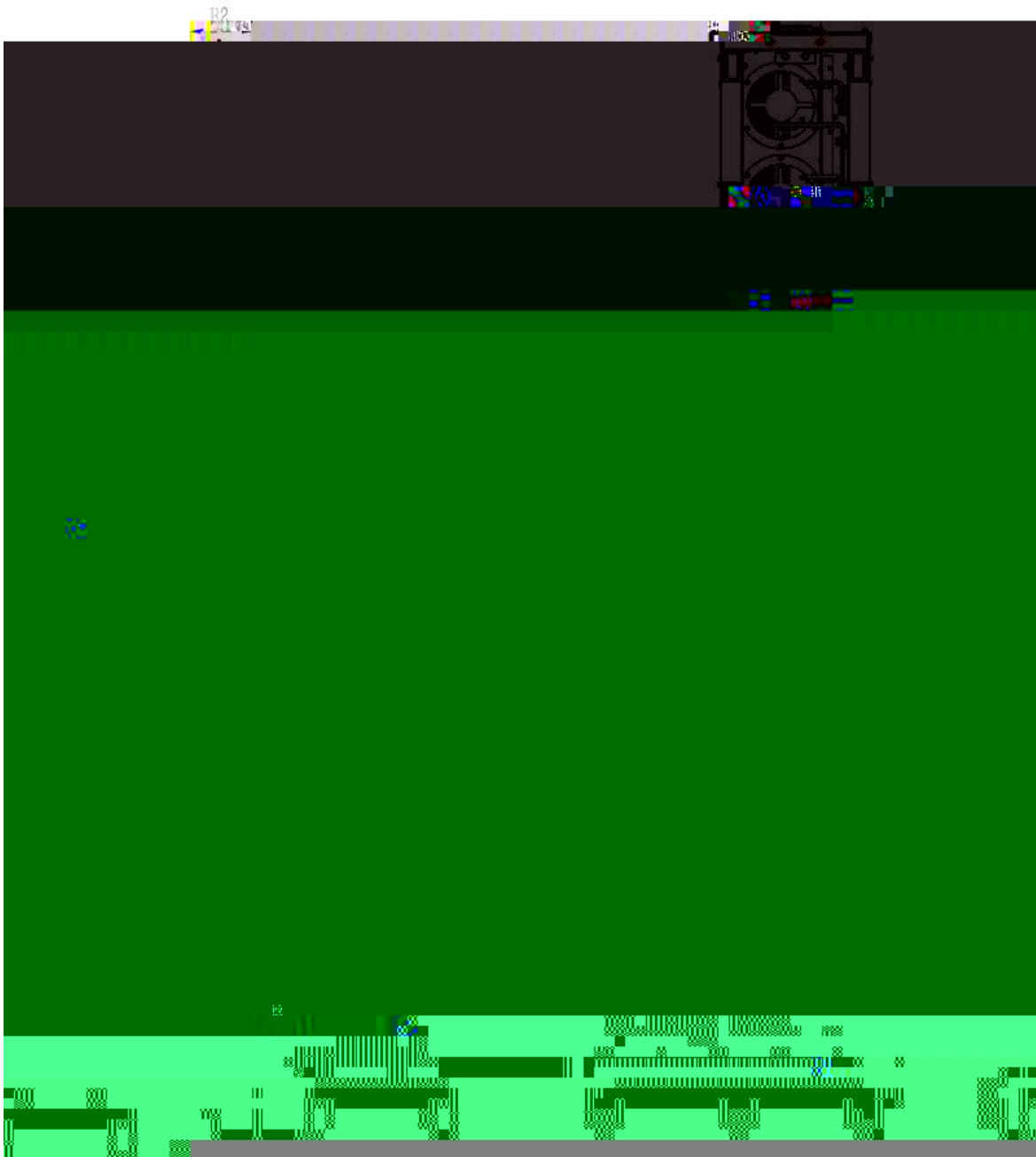

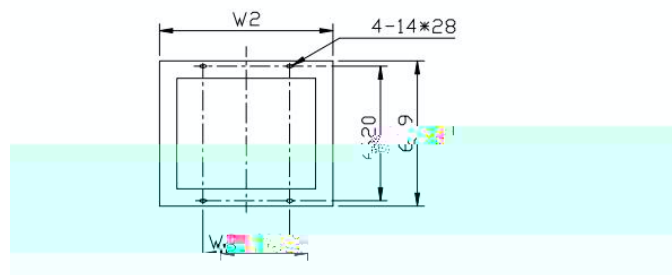
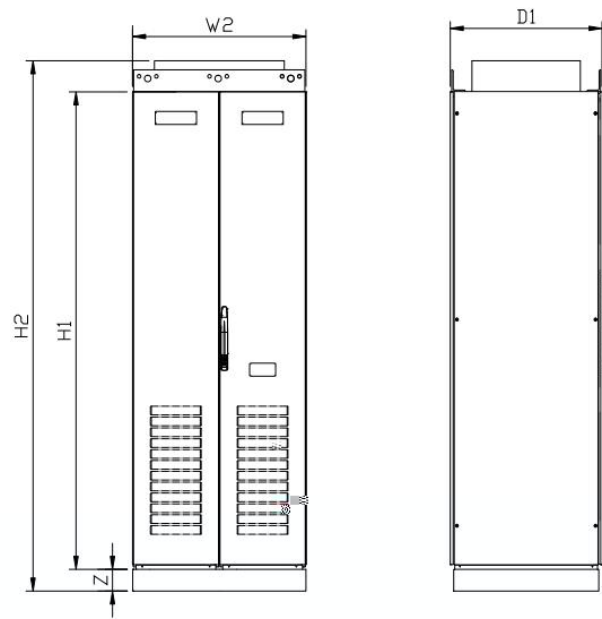

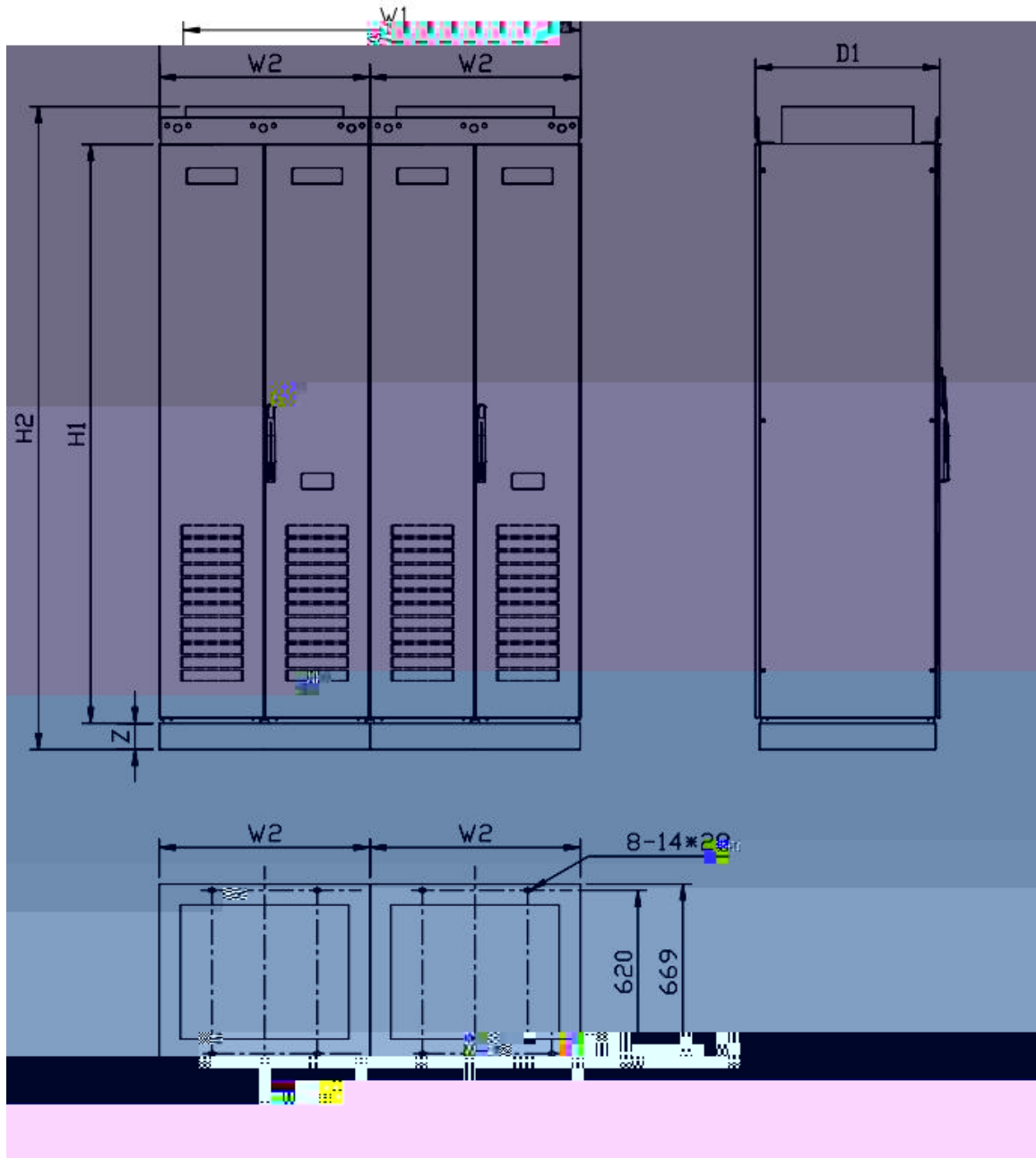

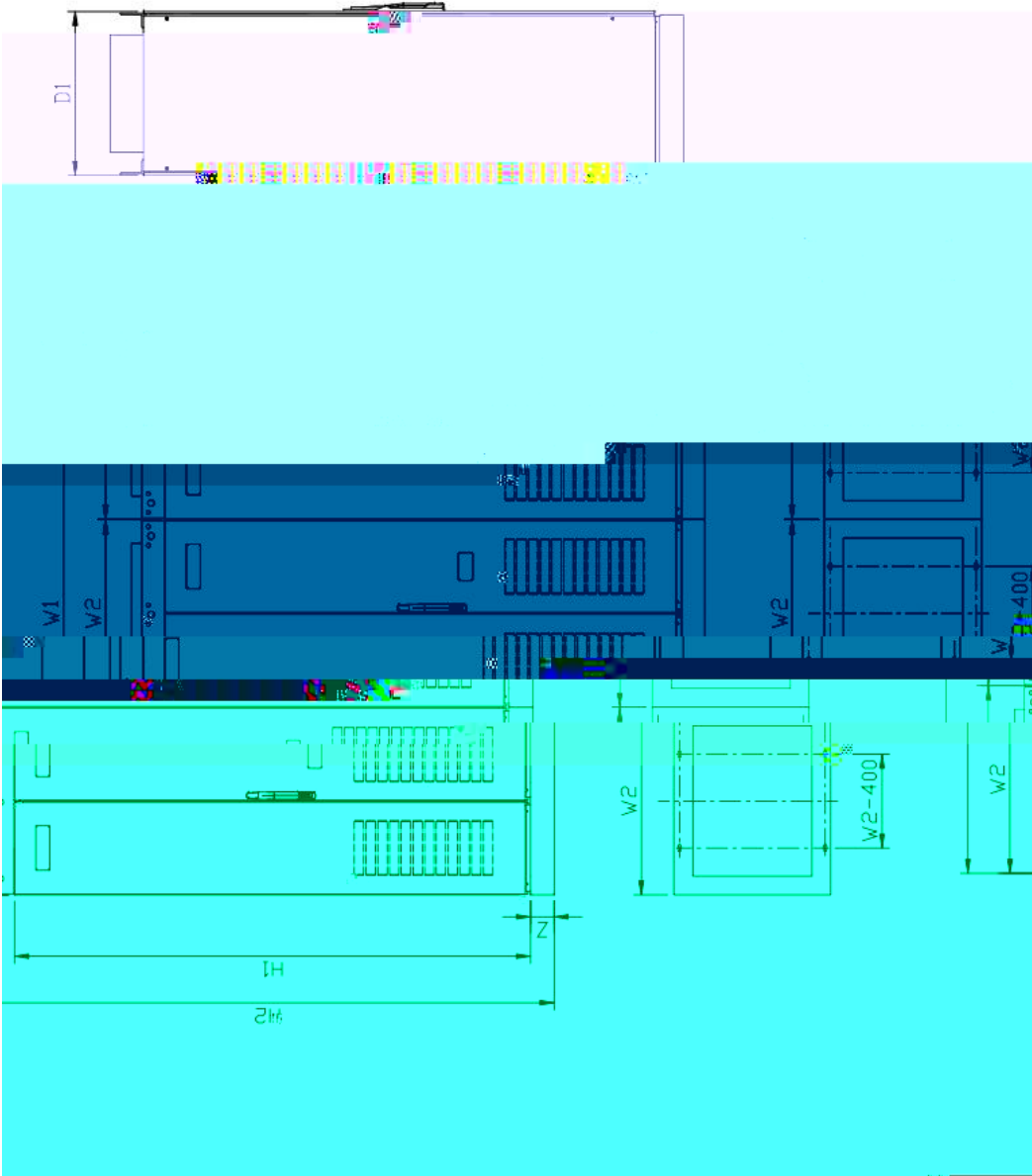

HF650A-1200-4-C

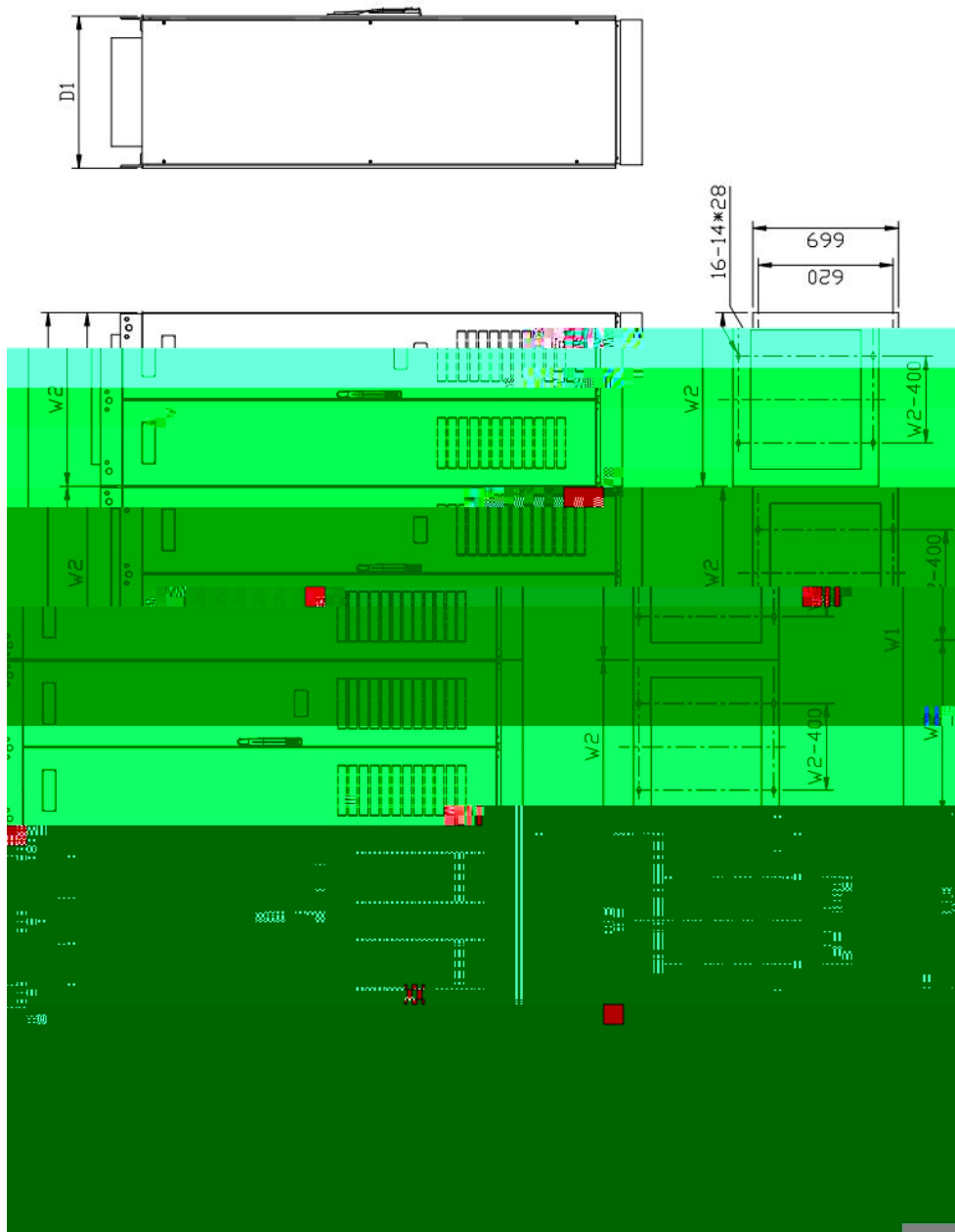

HF650A-1600-4-C





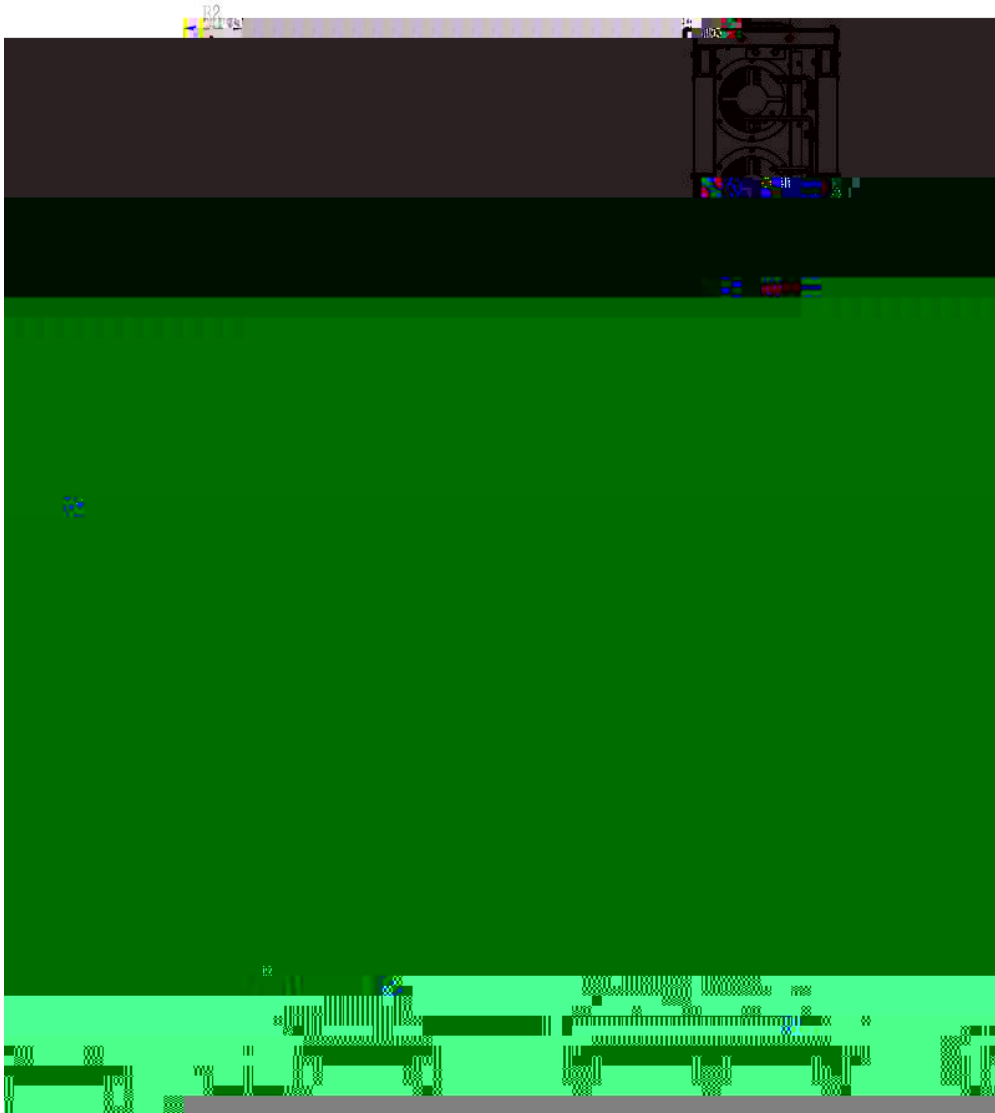

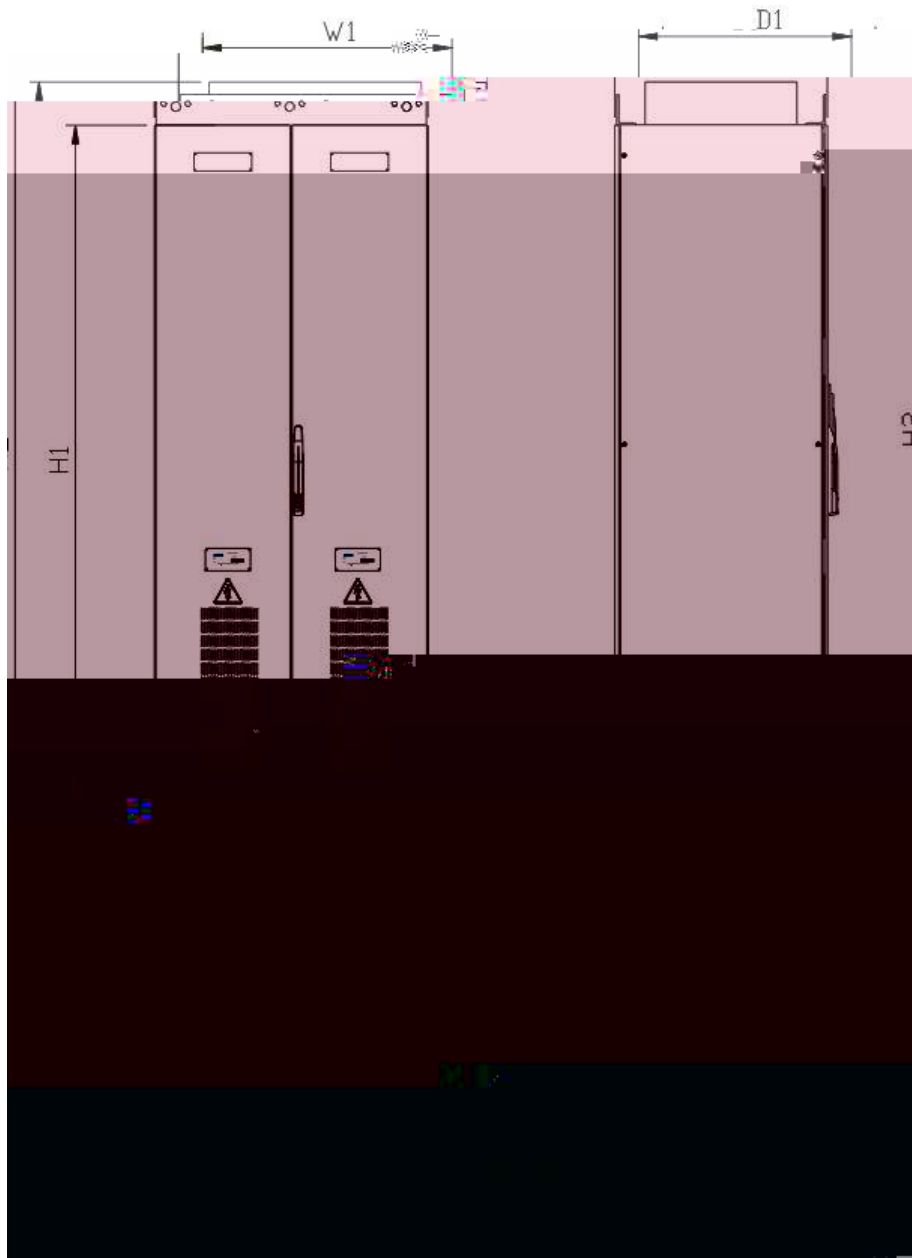











ΣΦΕΠ

ΣΦΕΠ

■ ■

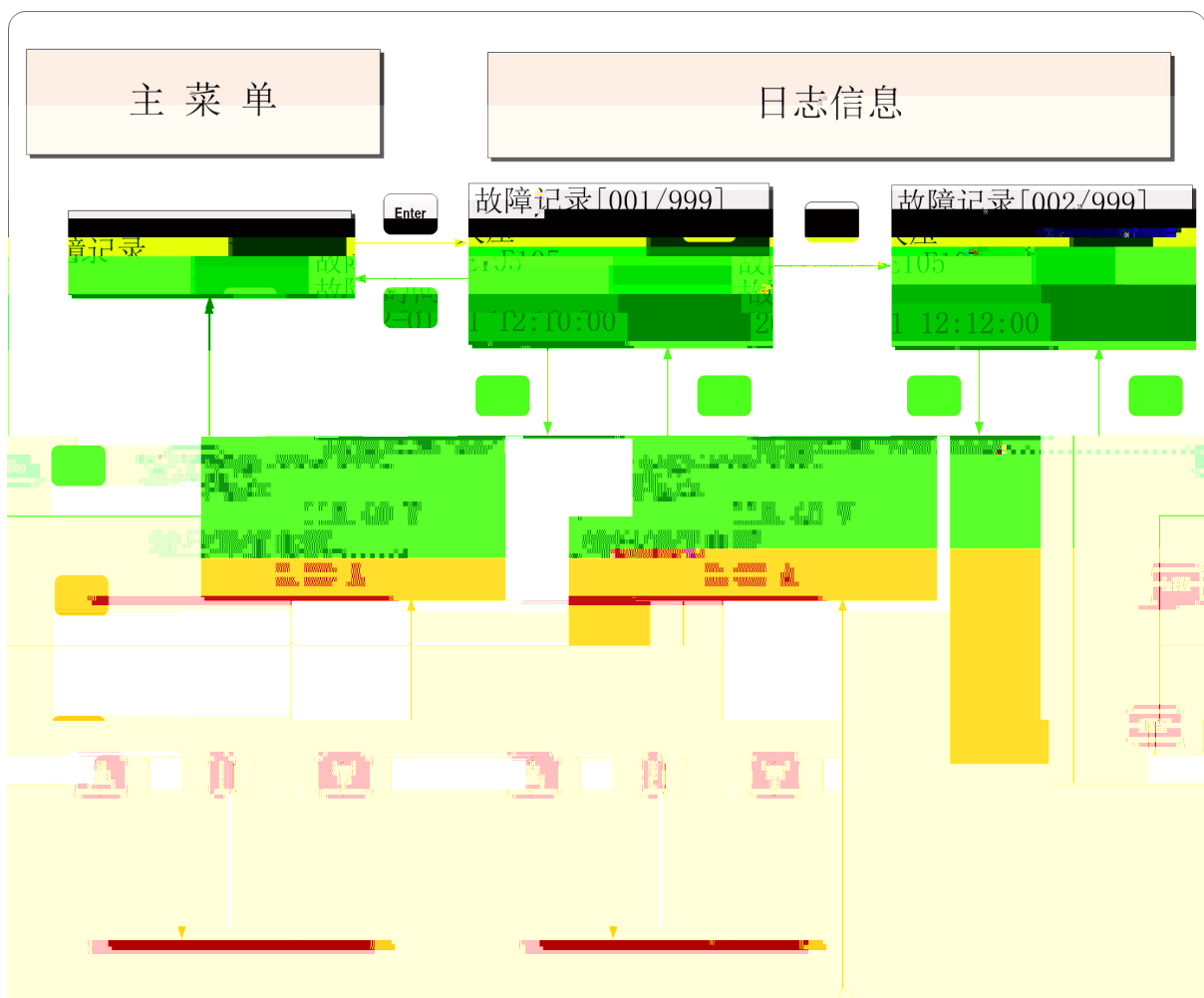

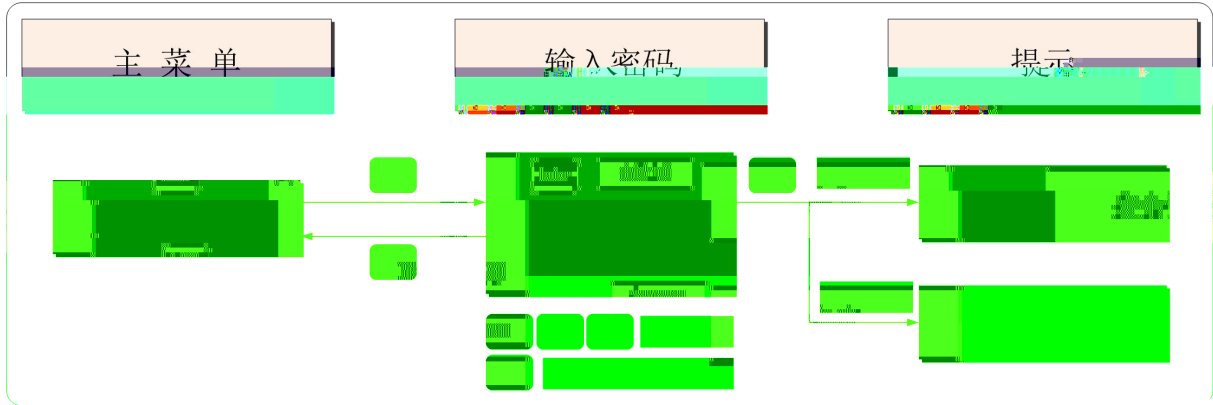



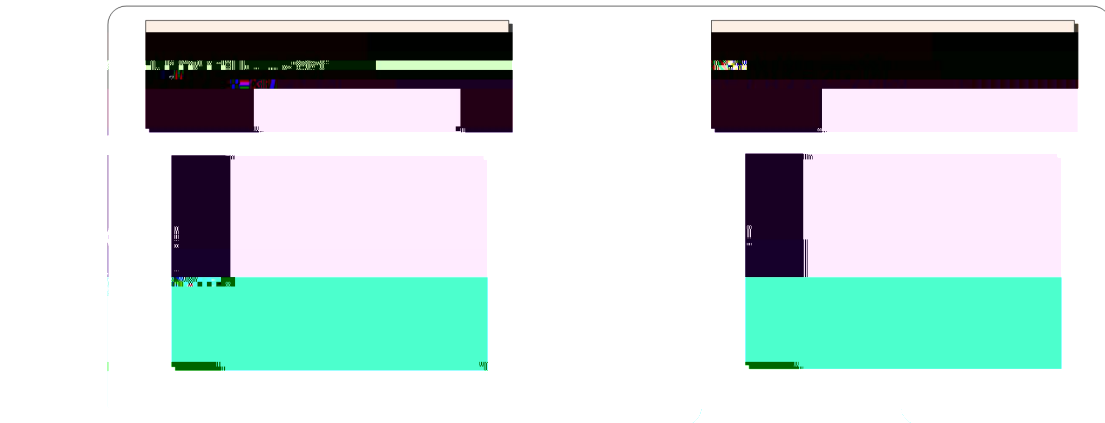
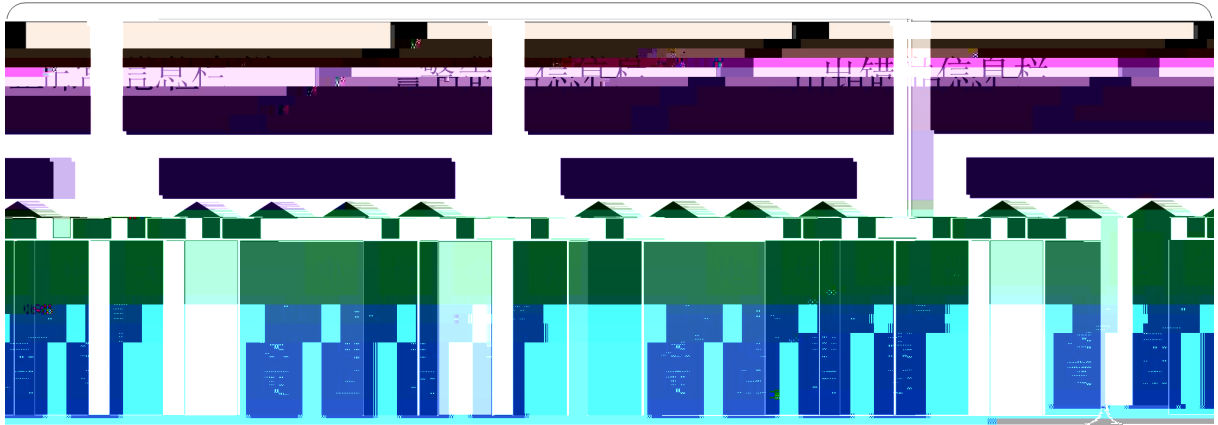



运行

停止

运行

停止

电容自学习

停止

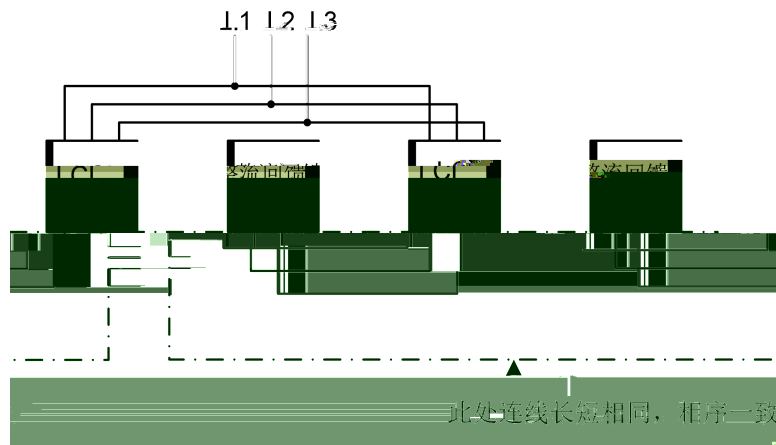

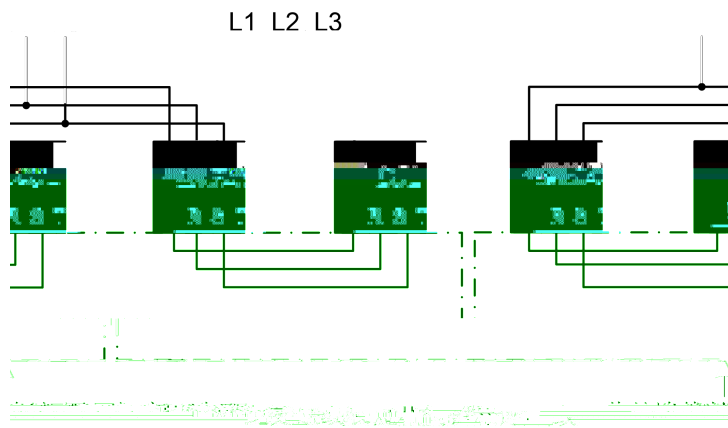

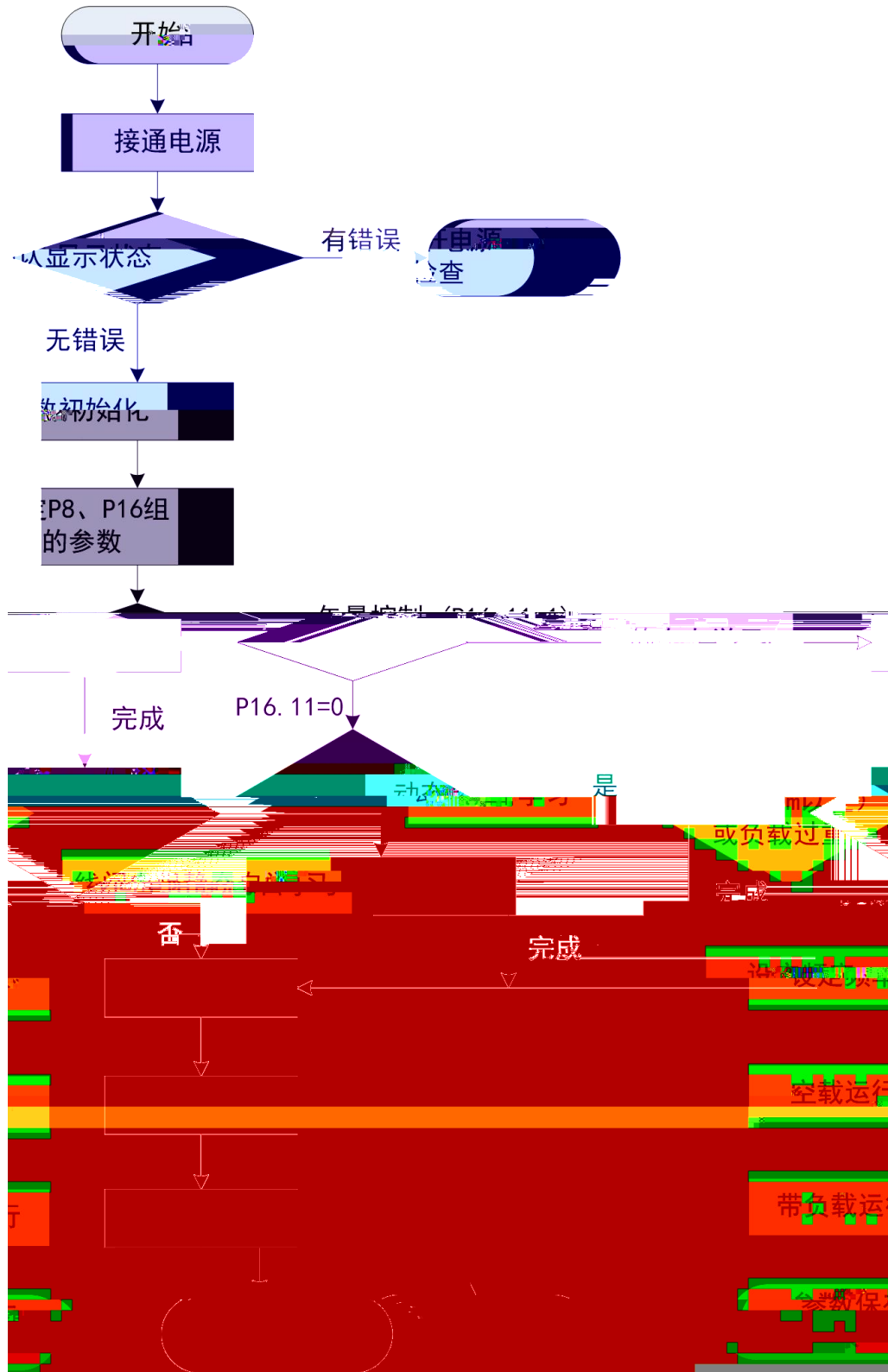









--	--	--	--	--	--













