

GF 630N01

1. 01







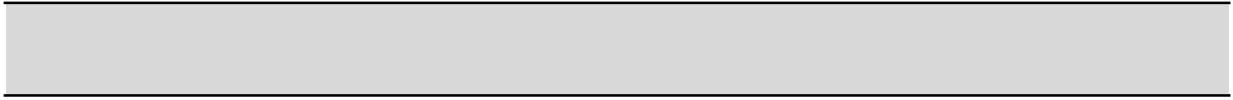



| | | |
|-------|-------|----|
| | | 1 |
| | | 1 |
| | | 3 |
| | | 5 |
| | | 7 |
| | | 7 |
| | | 9 |
| | | 9 |
| | | 10 |
| | | 11 |
| | | 11 |
| | | 12 |
| | | 13 |
| | | 13 |
| | | 15 |
| | | 15 |
| | | 17 |
| | | 17 |
| | | 18 |
| | | 18 |
| | | 18 |
| | | 19 |
| | | 22 |
| 3.3.1 | | 23 |
| 3.3.2 | | 24 |
| | | 26 |
| | | 26 |
| | | 29 |
| | | 30 |
| | | 31 |
| | | 31 |
| | | 33 |
| | | 33 |
| | | 33 |
| | | 34 |
| | | 34 |
| | | 35 |
| | | 37 |
| | | 37 |
| | | 37 |
| | | 43 |
| | | 43 |
| | | 44 |
| | | 44 |
| | | 45 |
| | | 46 |

e

ò
M'
@
FBAÙ€ V ä
Q
Eoá0 ypÓá0

M'
ú.79266
Q'ú ô

Bb

4
5
53
55
57
58
59
64..mç pĚ , ñθ Ÿ

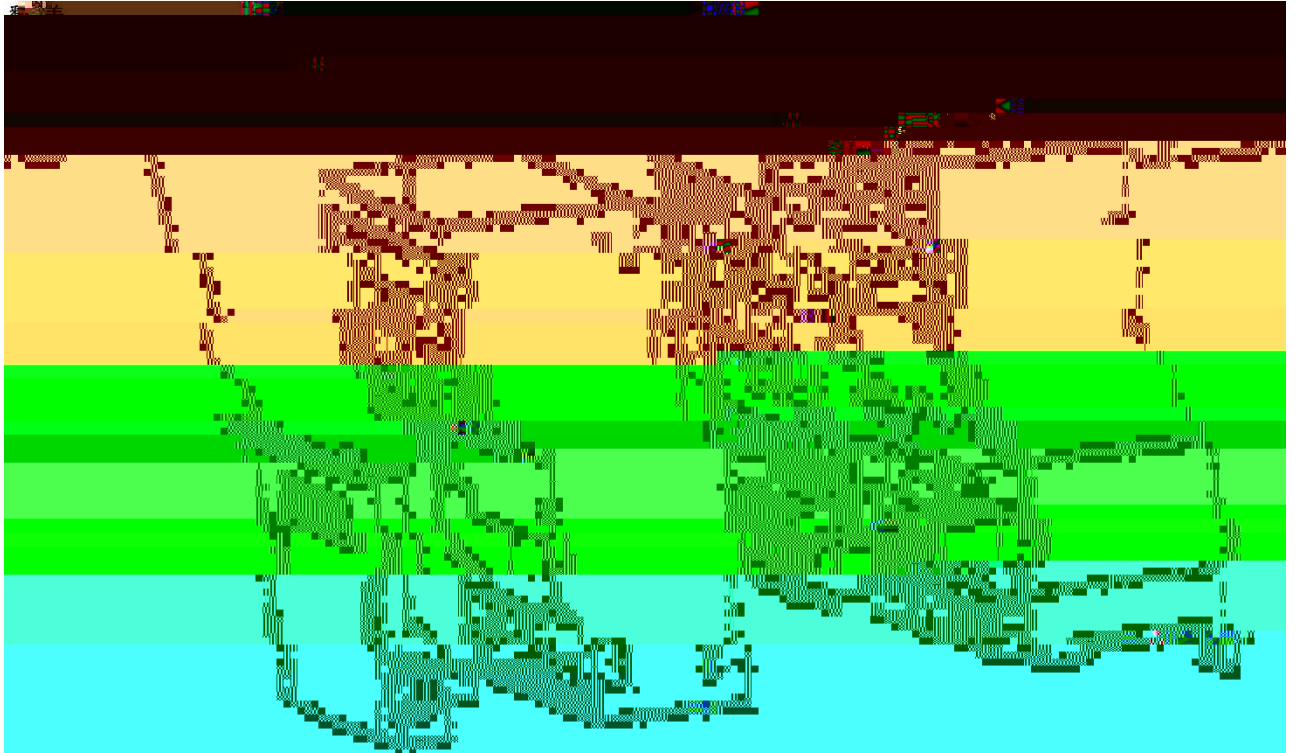

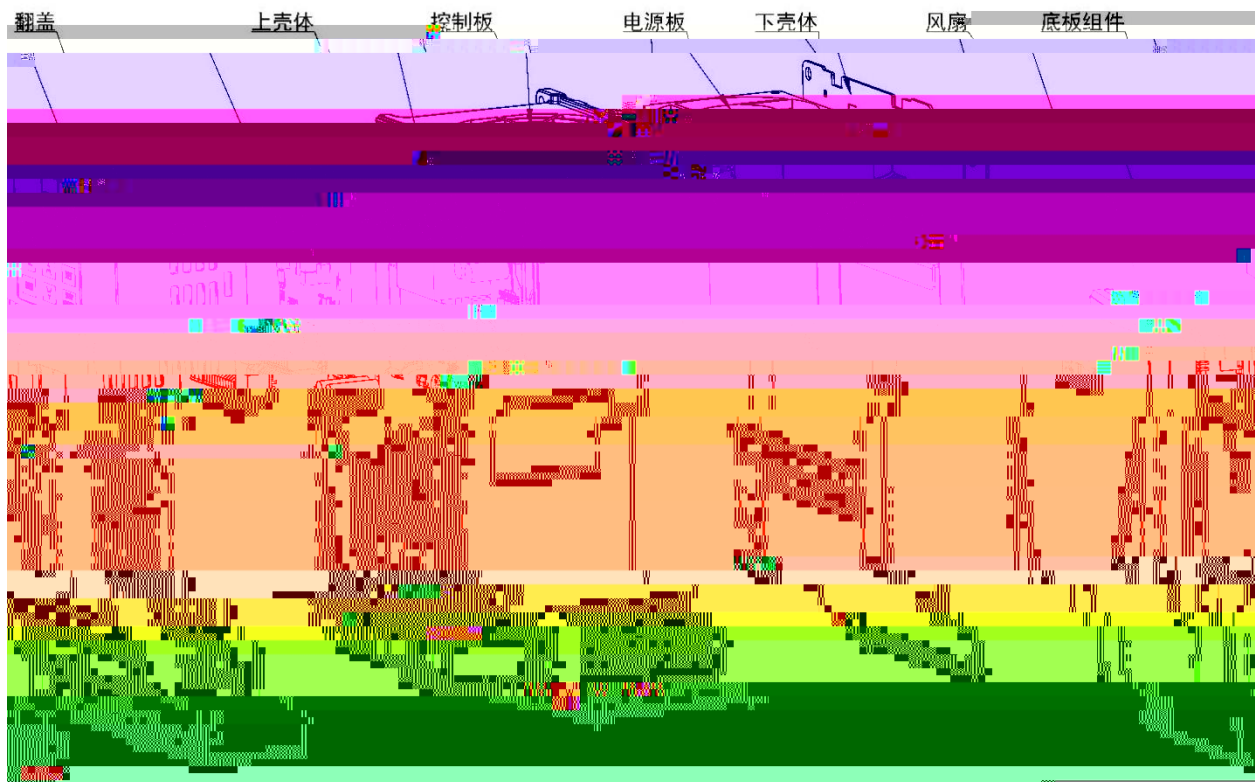

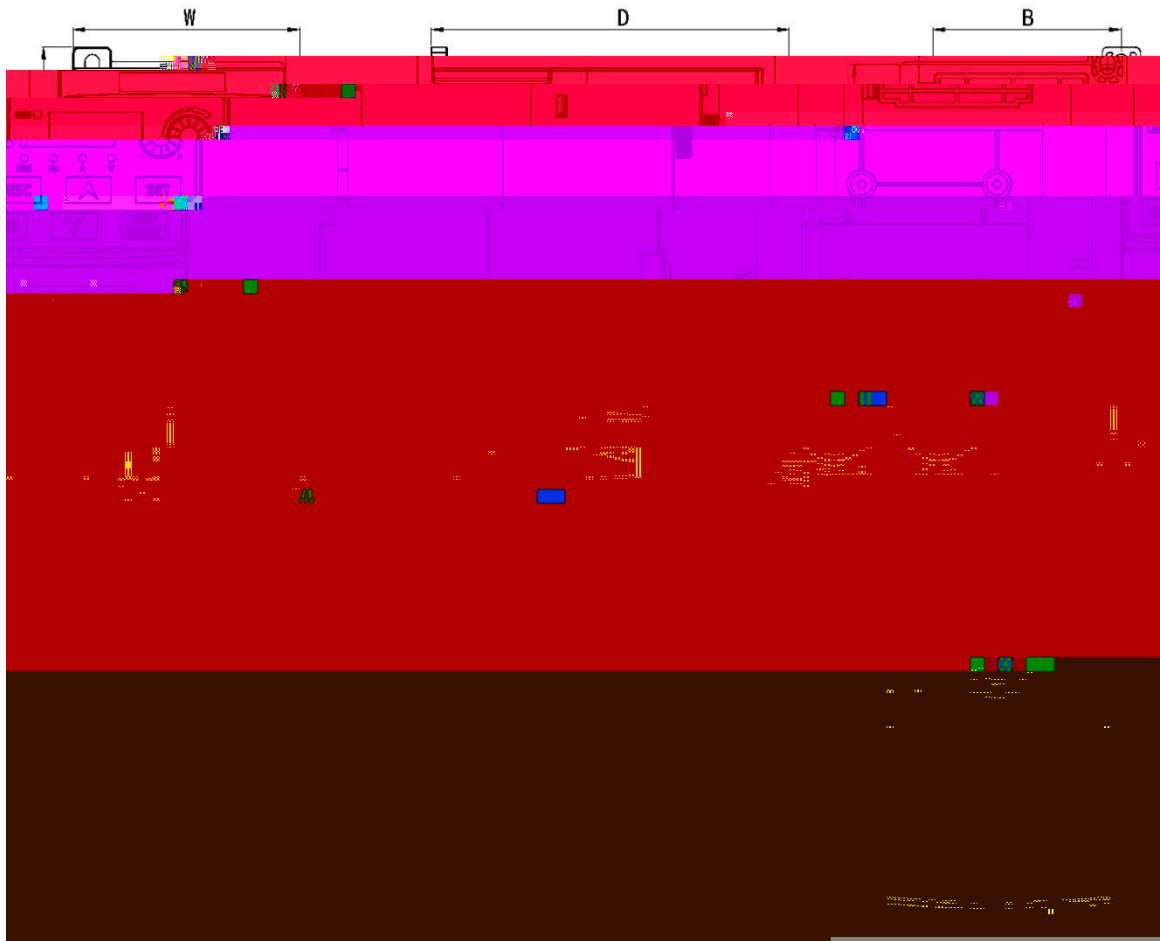

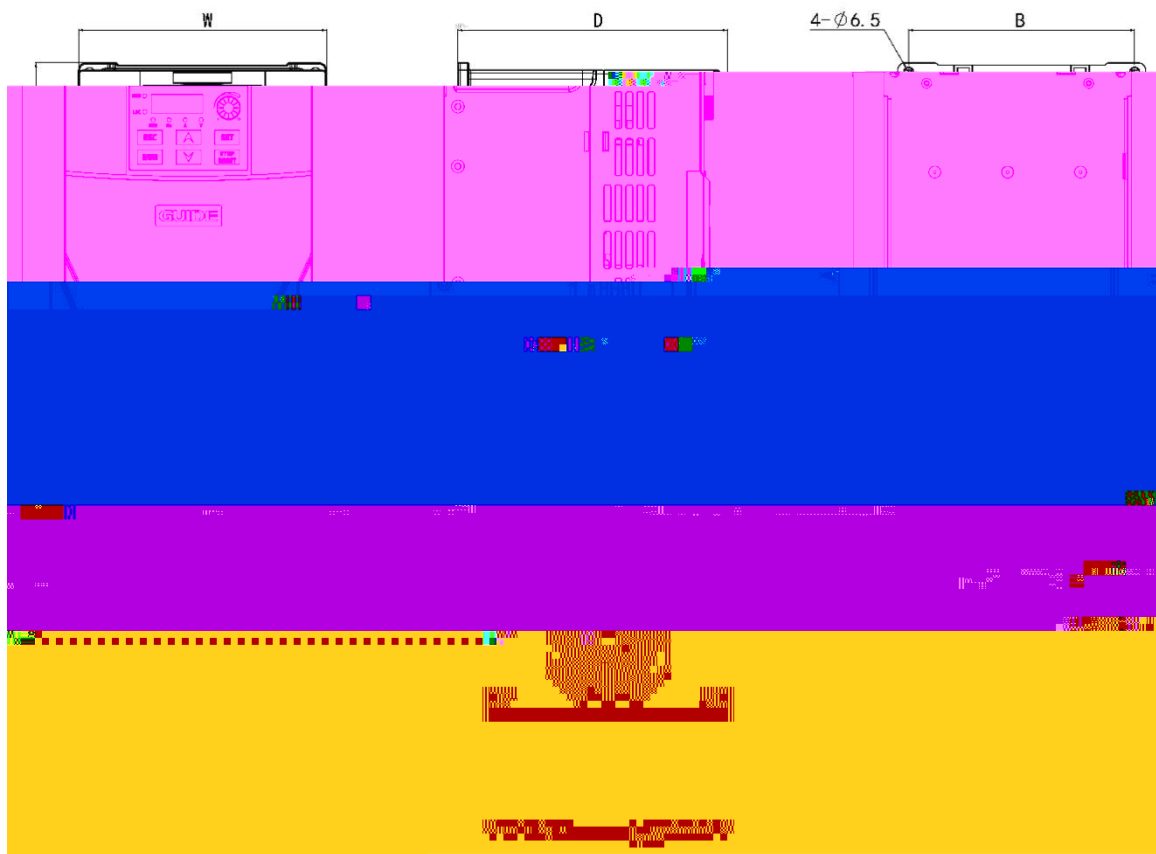



| |
|--|
| |
| |
| |
| |
| |

AC380V



GF630N01系列变频器

断路器



熔断器



接触器

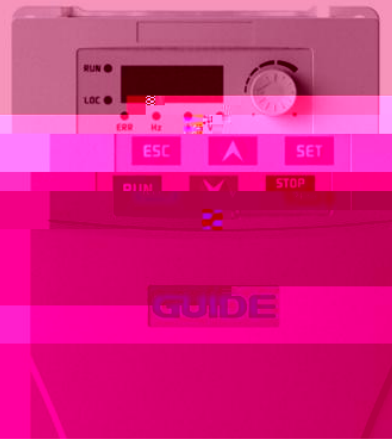

热继电器



电动机

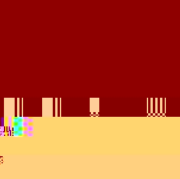

变频器





| | | | | | | |
|--|--|--|--|--|--|--|
| | | | | | | |
| | | | | | | |

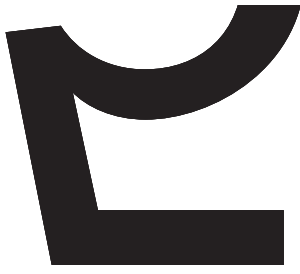

| | | | | |
|--|--|--|--|--|
| | | | | |
| | | | | |
| | | | | |
| | | | | |
| | | | | |
| | | | | |
| | | | | |
| | | | | |
| | | | | |
| | | | | |



~~XXXXXXXXXXXXXXXXXXXX~~



~~XXXXXXXXXXXX~~



~~XXXXXXXXXXXX~~



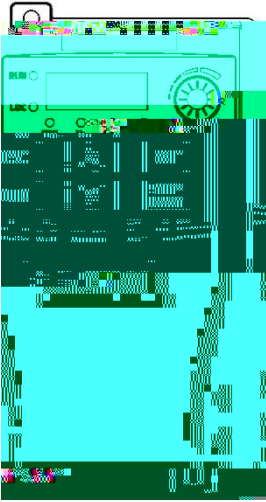



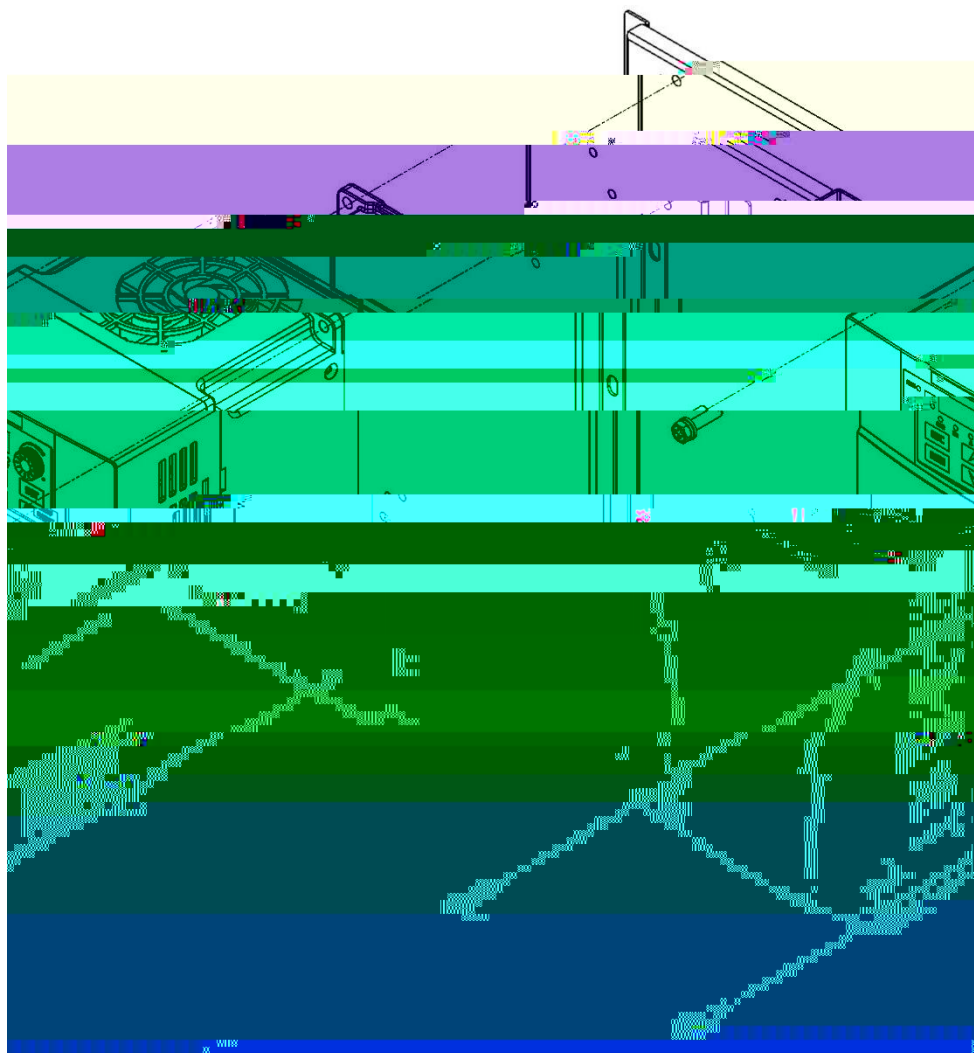

| | | | |
|--|--|--|--|
| | | | |
| | | | |
| | | | |
| | | | |
| | | | |

3.3.1

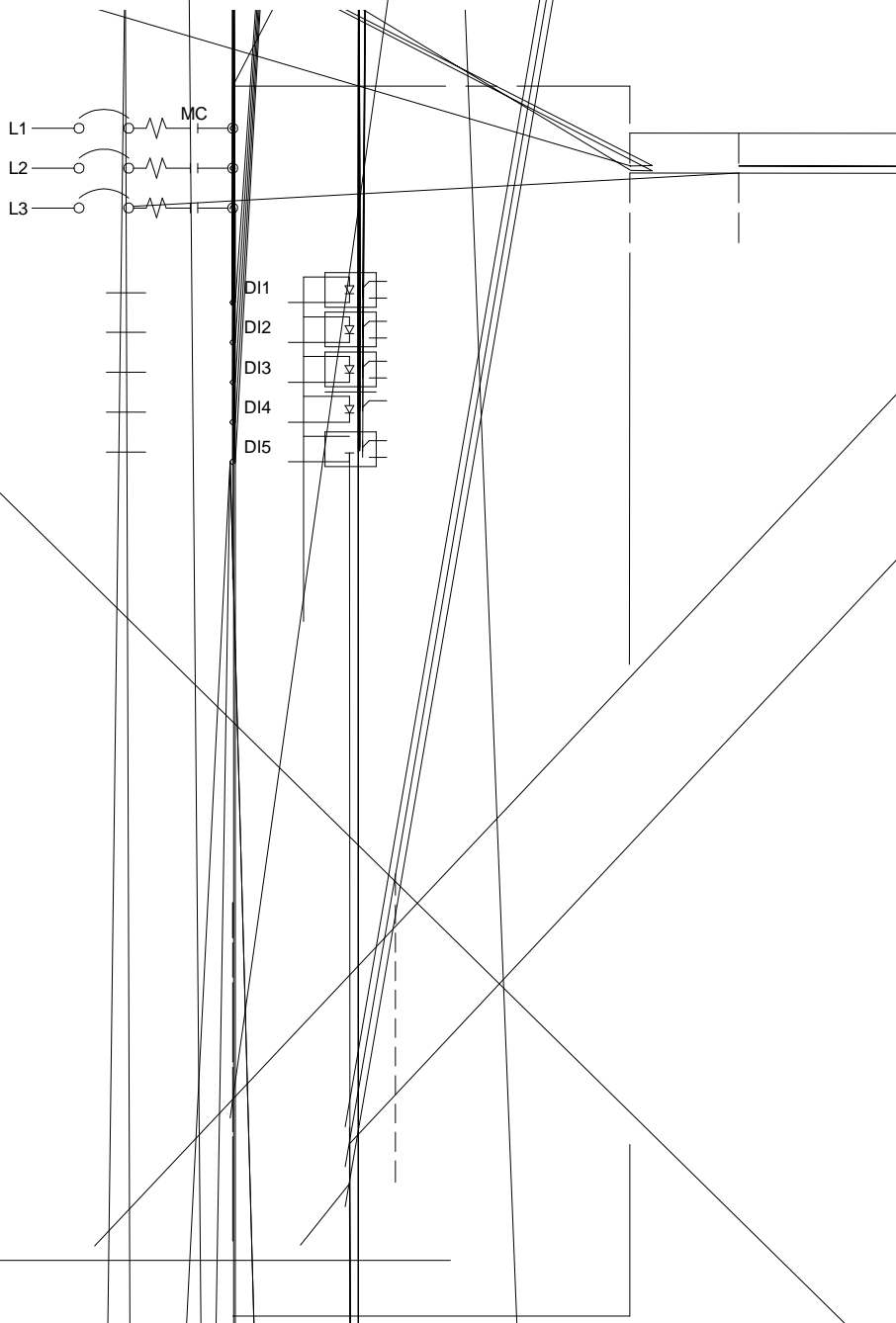

3.3.1

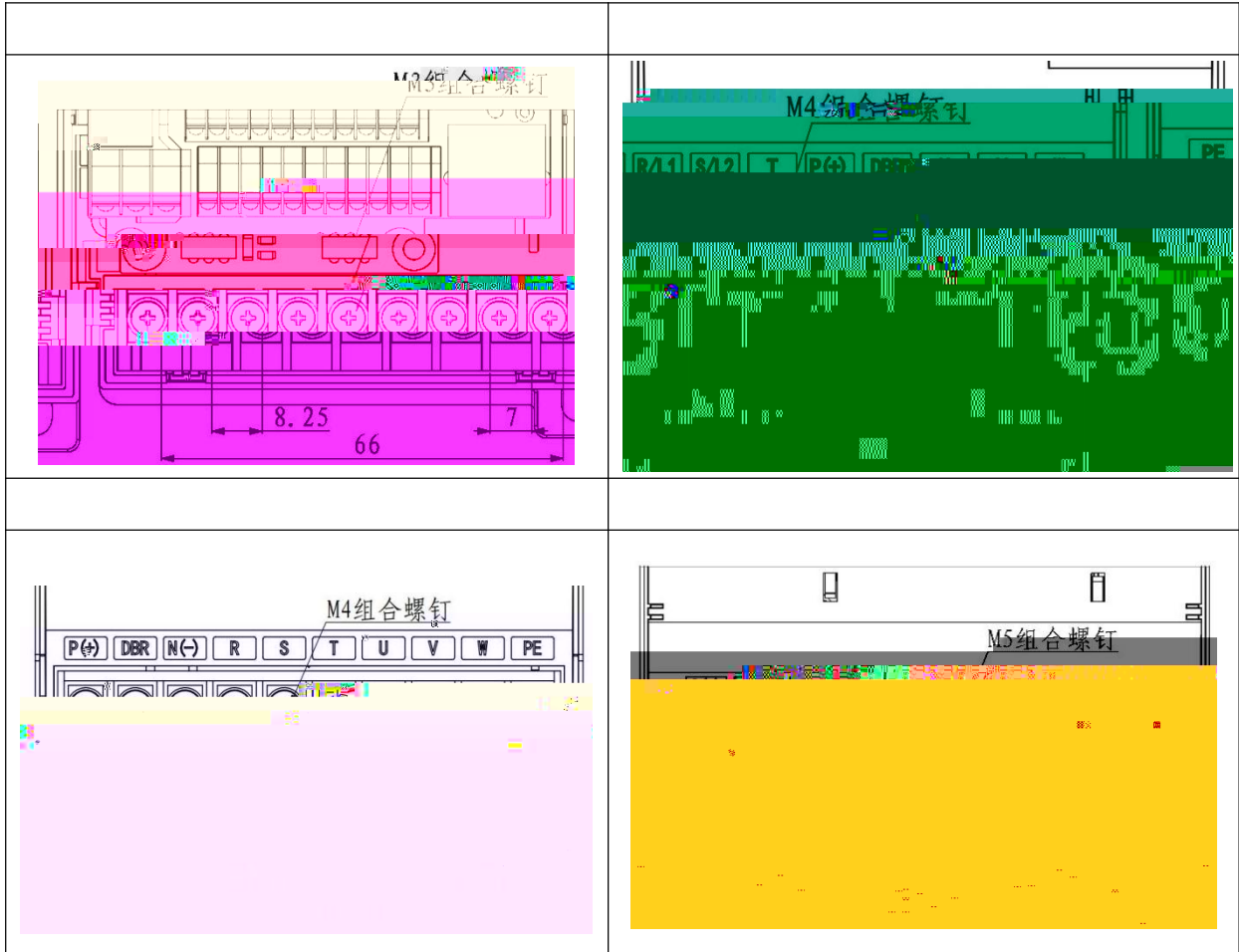

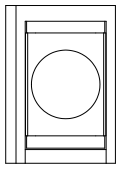

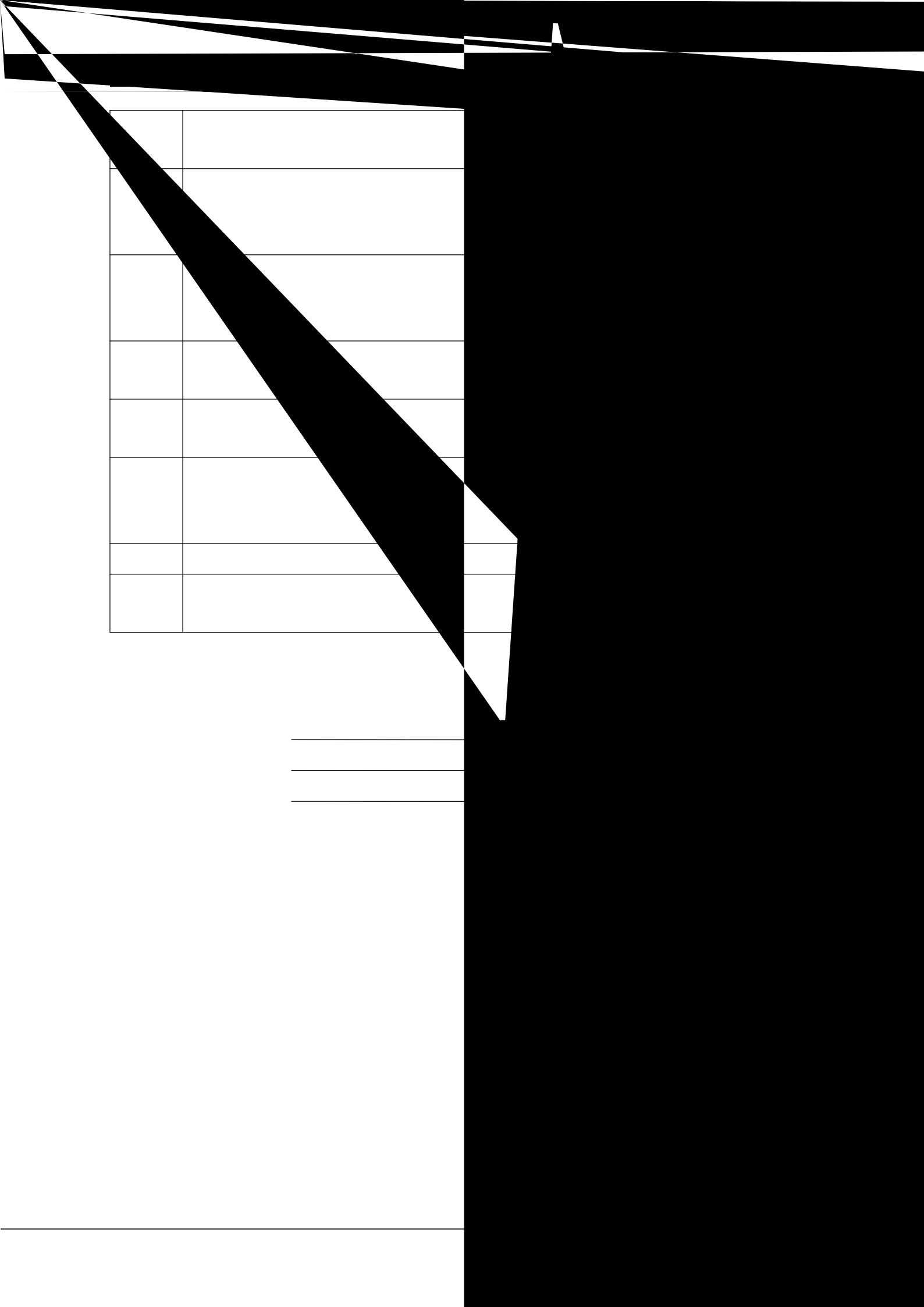

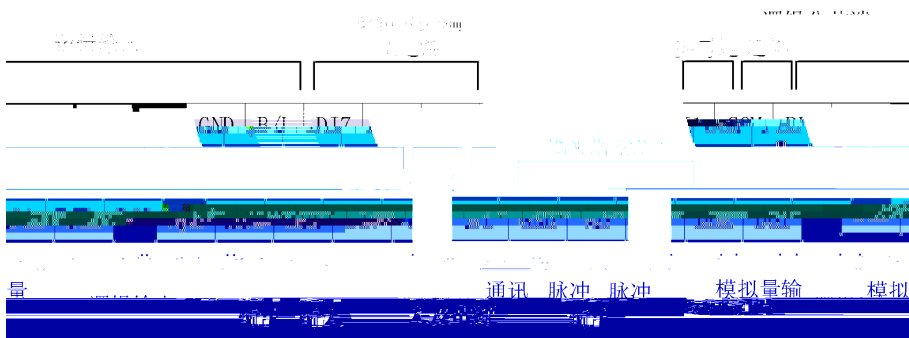
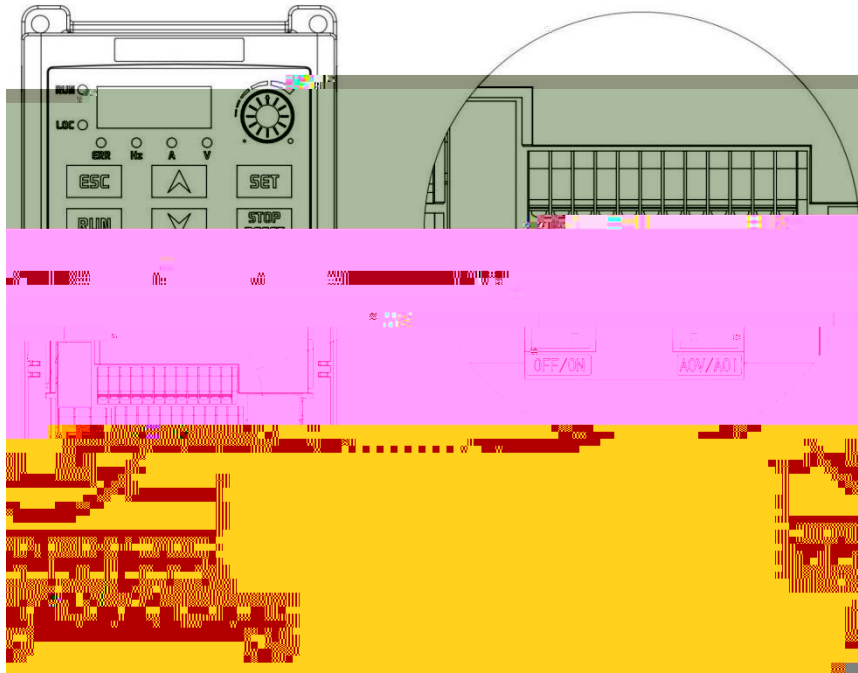

模拟量输入

模拟量输出



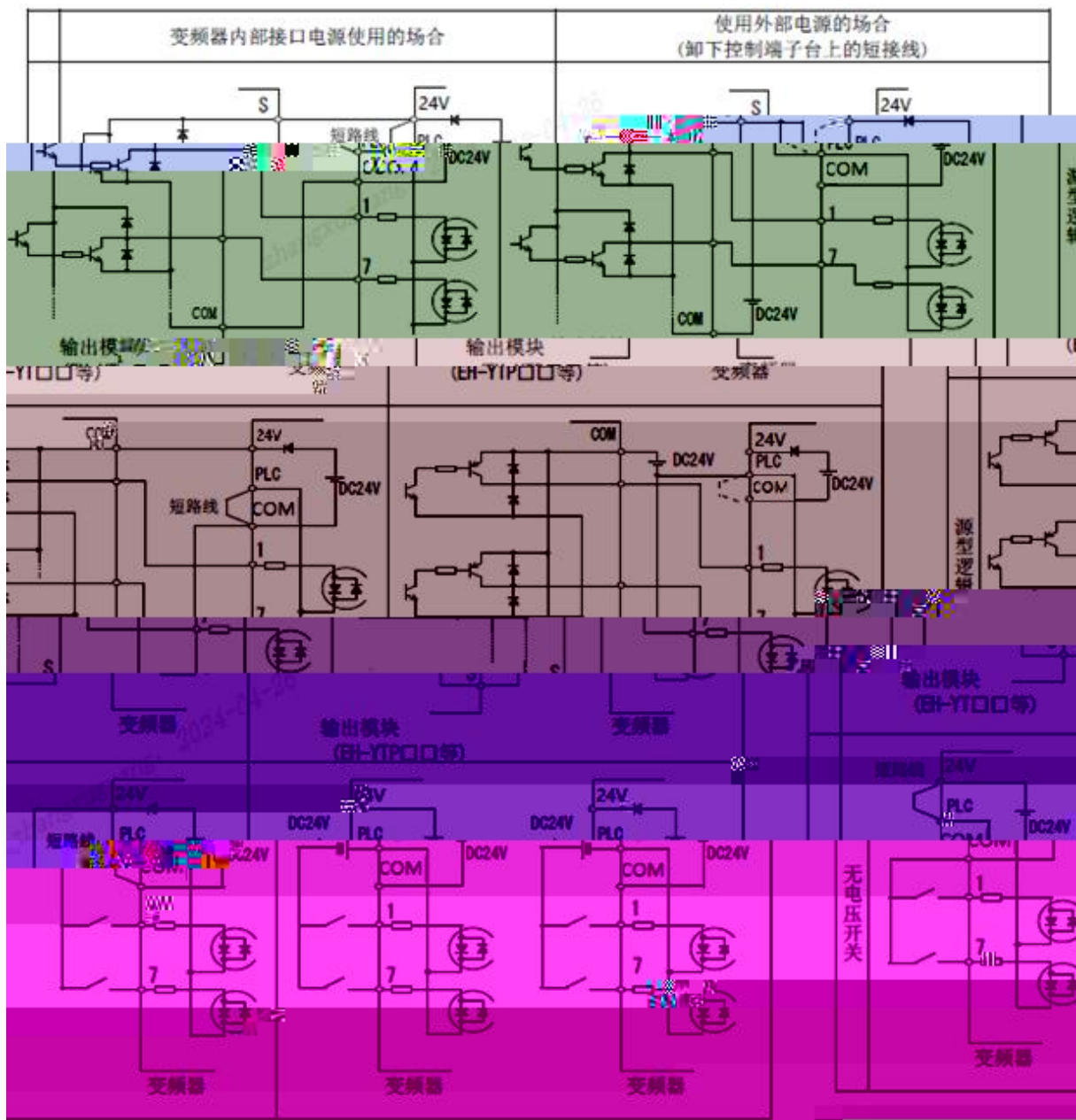
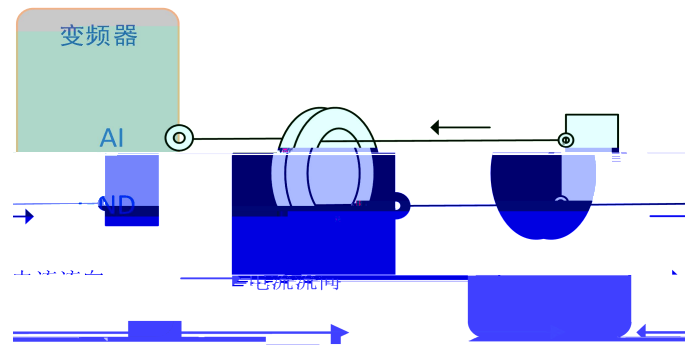

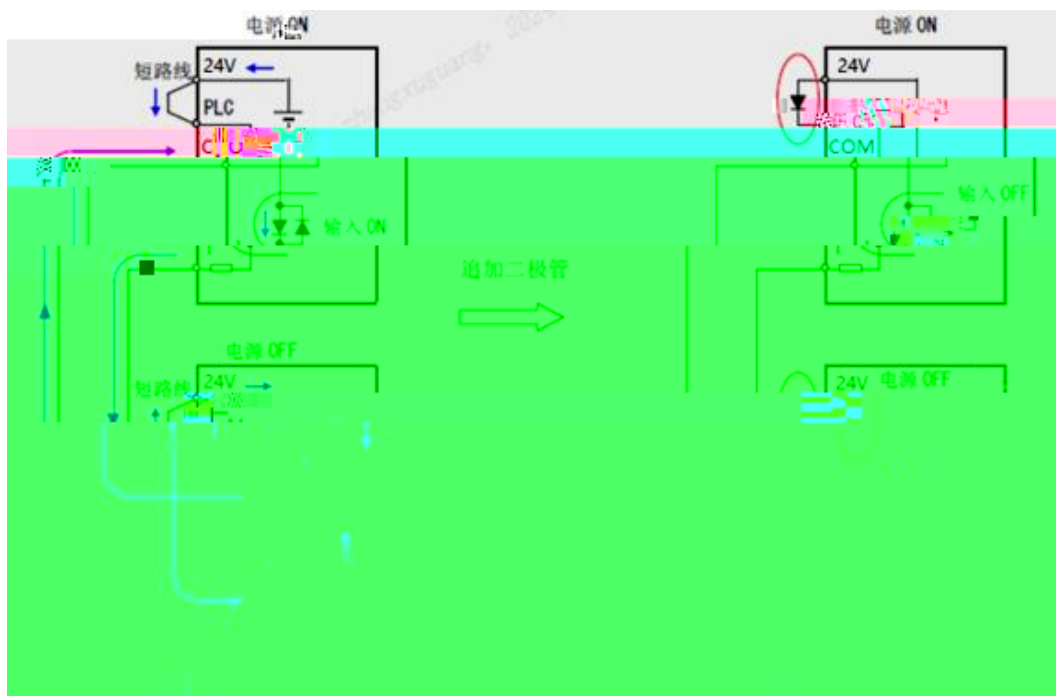

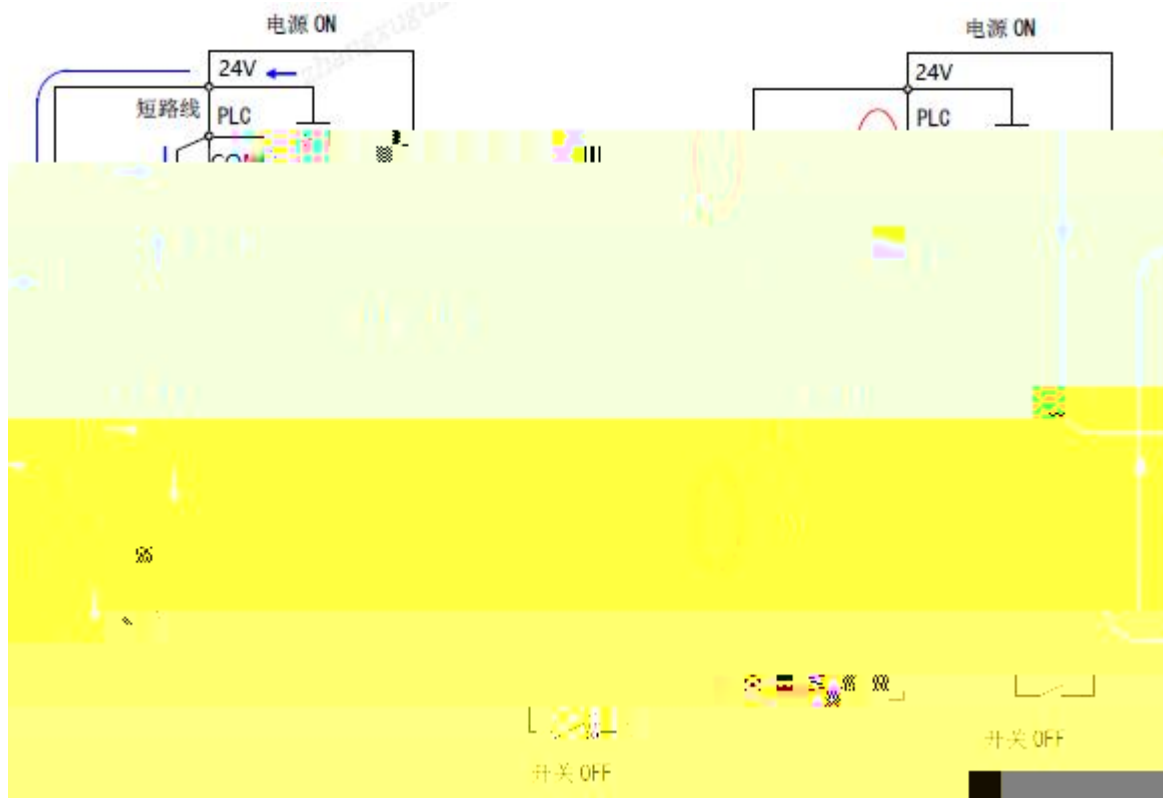



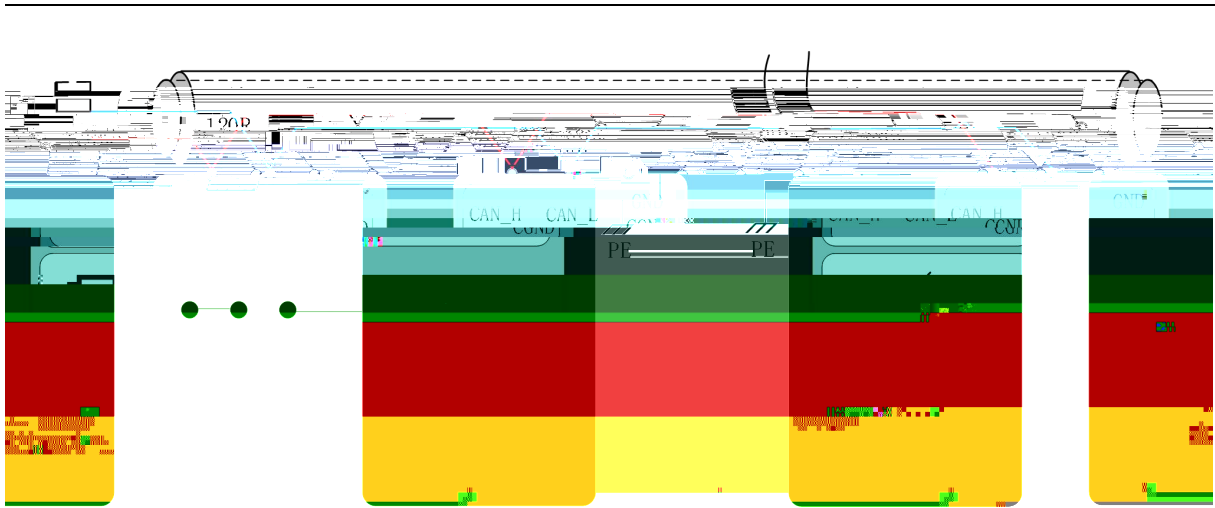



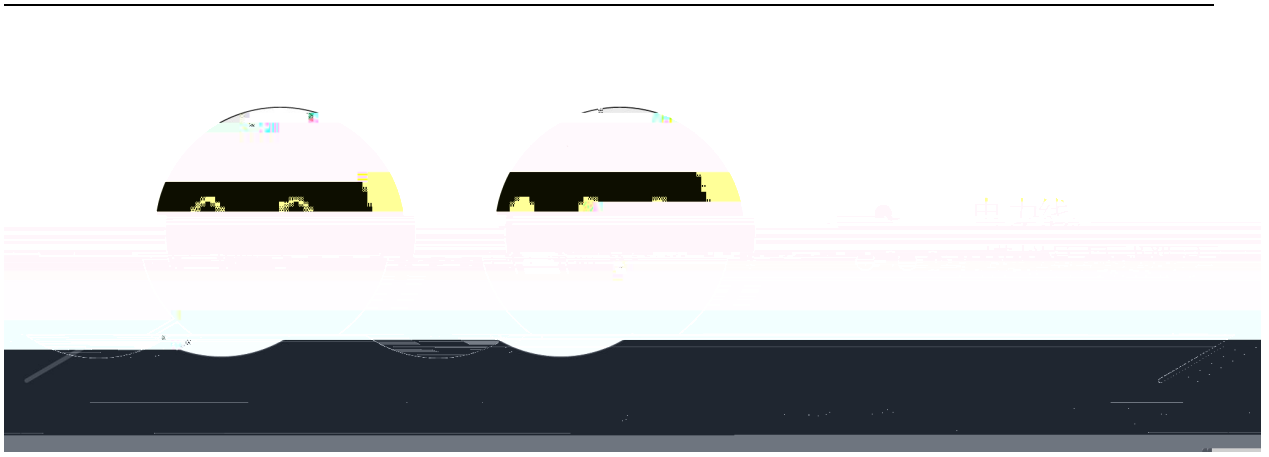

.

<

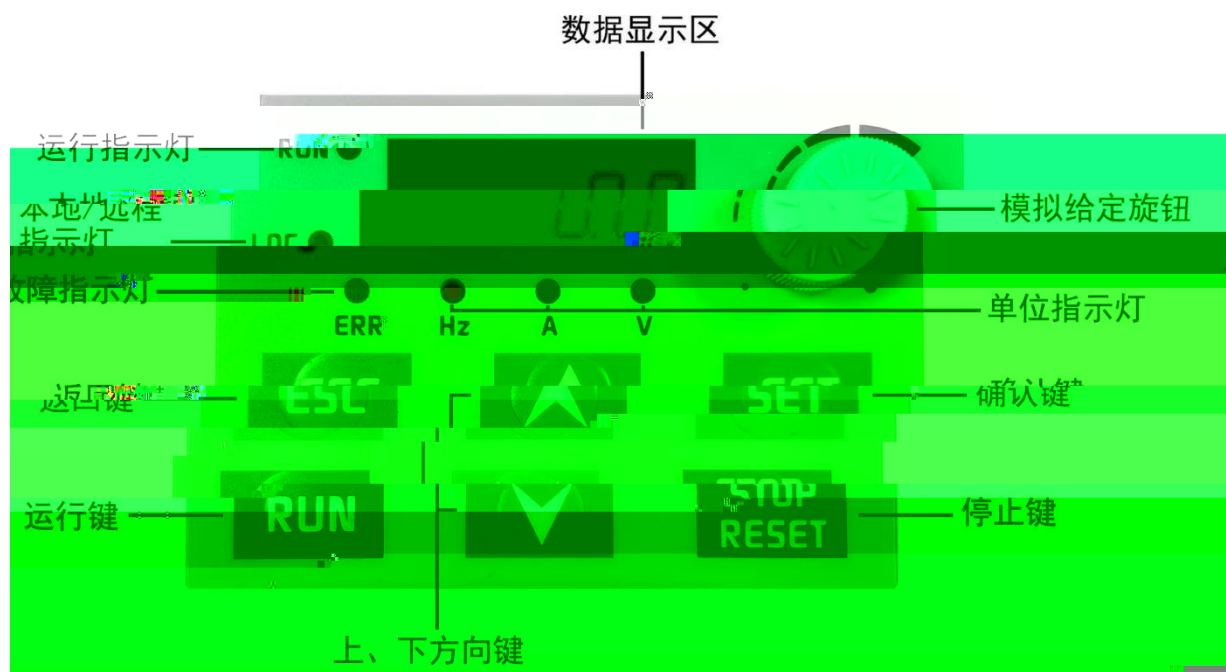



| 显示文字 | LED显示 | 显示文字 | LED显示 | 显示文字 | LED显示 | 显示文字 | LED显示 |
|------|-------|------|-------|------|-------|------|-------|
| 0 | 0 | A | A | K | Ʒ | U | U |
| 1 | 1 | B | B | L | L | V | V |
| 2 | 2 | C | C | M | 无 | W | 无 |
| 3 | 3 | D | d | N | n | X | 无 |
| 4 | 4 | E | E | O | o | Y | Ʒ |
| 5 | 5 | F | F | P | p | Z | 无 |
| 6 | 6 | G | G | Q | q | | |
| 7 | 7 | H | H | R | r | | |
| 8 | 8 | I | I | S | s | | |
| 9 | 9 | J | J | T | t | | |

| | | |
|---|--|--|
| | | |
|  | | |
|  | | |







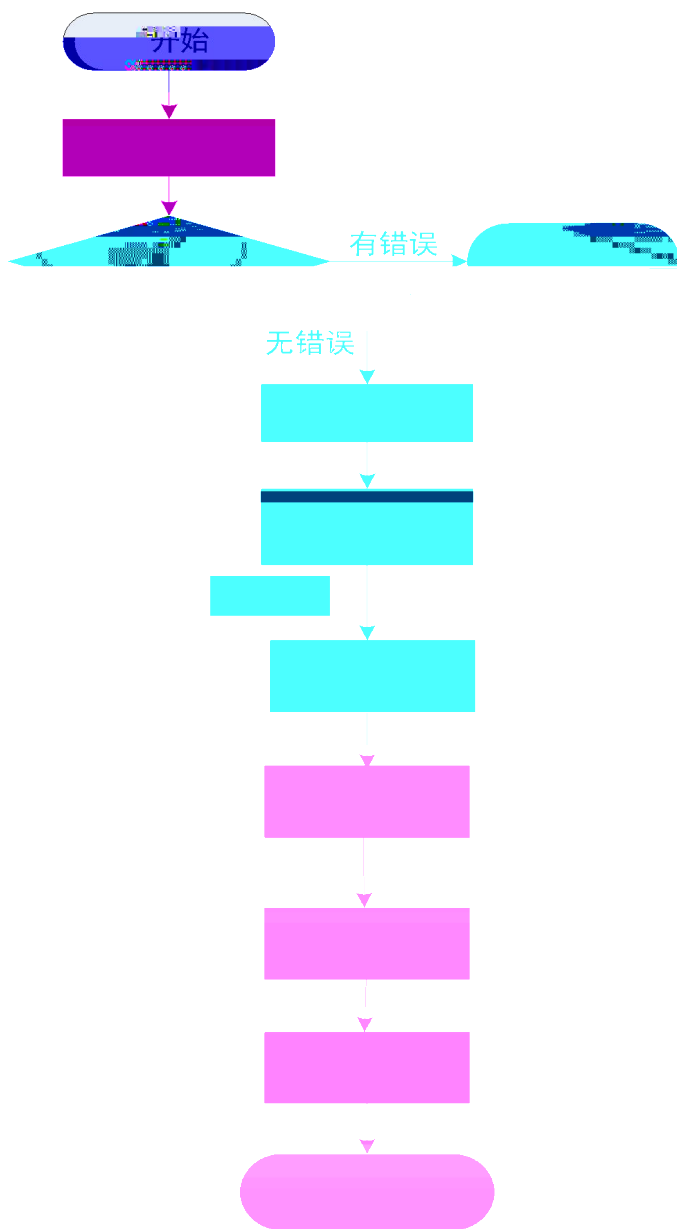

| | | |
|--|--|--|
| | | |
| | | |
| | | |

| | |
|--|--|
| | |
| | |
| | |
| | |

| | | |
|--|--|--|
| | | |
| | | |
| | | |
| | | |
| | | |
| | | |
| | | |
| | | |

| | | |
|--|--|--|
| | | |
| | | |
| | | |
| | | |
| | | |
| | | |
| | | |
| | | |
| | | |
| | | |
| | | |
| | | |
| | | |
| | | |
| | | |
| | | |
| | | |
| | | |

| | | | |
|--|--|--|--|
| | | | |
| | | | |
| | | | |
| | | | |
| | | | |
| | | | |
| | | | |
| | | | |
| | | | |
| | | | |
| | | | |
| | | | |
| | | | |
| | | | |
| | | | |

| | | | | |
|--|--|--|--|--|
| | | | | |
| | | | | |
| | | | | |
| | | | | |
| | | | | |
| | | | | |
| | | | | |

| | | | | |
|--|--|--|--|--|
| | | | | |
| | | | | |
| | | | | |

| | | | | |
|--|--|--|--|--|
| | | | | |
| | | | | |

| | | | | |
|--|--|--|--|--|
| | | | | |
| | | | | |
| | | | | |
| | | | | |
| | | | | |
| | | | | |
| | | | | |
| | | | | |
| | | | | |
| | | | | |
| | | | | |
| | | | | |

OE

o

ö

ö

ä

öLi



| | | | | |
|--|--|--|--|--|
| | | | | |
| | | | | |
| | | | | |



Bible*

| | | | | |
|--|--|--|--|--|
| | | | | |
| | | | | |

| | | | | |
|--|--|--|--|--|
| | | | | |
| | | | | |
| | | | | |
| | | | | |
| | | | | |
| | | | | |
| | | | | |
| | | | | |

| | | | | |
|--|--|--|--|--|
| | | | | |
| | | | | |
| | | | | |
| | | | | |
| | | | | |
| | | | | |
| | | | | |
| | | | | |
| | | | | |
| | | | | |
| | | | | |
| | | | | |
| | | | | |
| | | | | |
| | | | | |
| | | | | |
| | | | | |
| | | | | |
| | | | | |
| | | | | |
| | | | | |
| | | | | |

| | | | | |
|--|--|--|--|--|
| | | | | |
| | | | | |
| | | | | |

| | | | | |
|--|--|--|--|--|
| | | | | |
| | | | | |
| | | | | |
| | | | | |
| | | | | |
| | | | | |
| | | | | |
| | | | | |
| | | | | |
| | | | | |
| | | | | |

| | | | | |
|--|--|--|--|--|
| | | | | |
| | | | | |
| | | | | |
| | | | | |
| | | | | |
| | | | | |
| | | | | |
| | | | | |
| | | | | |
| | | | | |



| | | | | |
|--|--|--|--|--|
| | | | | |
| | | | | |
| | | | | |
| | | | | |
| | | | | |
| | | | | |
| | | | | |
| | | | | |
| | | | | |
| | | | | |
| | | | | |
| | | | | |
| | | | | |
| | | | | |



| | | | | |
|--|--|--|--|--|
| | | | | |
| | | | | |
| | | | | |



GUIDE



| | | | | |
|--|--|--|--|--|
| | | | | |
| | | | | |
| | | | | |
| | | | | |
| | | | | |
| | | | | |
| | | | | |





| | | | | |
|--|--|--|--|--|
| | | | | |
| | | | | |

| | | | | |
|--|--|--|--|--|
| | | | | |
| | | | | |
| | | | | |
| | | | | |
| | | | | |
| | | | | |
| | | | | |
| | | | | |
| | | | | |
| | | | | |
| | | | | |
| | | | | |
| | | | | |
| | | | | |
| | | | | |
| | | | | |
| | | | | |
| | | | | |
| | | | | |
| | | | | |
| | | | | |
| | | | | |
| | | | | |

| | | | | |
|--|--|--|--|--|
| | | | | |
| | | | | |
| | | | | |
| | | | | |





| | | | | |
|--|--|--|--|--|
| | | | | |
| | | | | |
| | | | | |
| | | | | |
| | | | | |
| | | | | |
| | | | | |
| | | | | |
| | | | | |
| | | | | |





| | | | | |
|--|--|--|--|--|
| | | | | |
| | | | | |
| | | | | |
| | | | | |
| | | | | |
| | | | | |
| | | | | |
| | | | | |
| | | | | |
| | | | | |
| | | | | |
| | | | | |



3





| | | | | |
|--|--|--|--|--|
| | | | | |
| | | | | |
| | | | | |

| | | | |
|--|--|--|--|
| | | | |
| | | | |

| | | | | |
|--|--|--|--|--|
| | | | | |
| | | | | |
| | | | | |
| | | | | |

| | | | |
|--|--|--|--|
| | | | |
| | | | |
| | | | |
| | | | |
| | | | |
| | | | |
| | | | |

| | | | |
|--|--|--|--|
| | | | |
| | | | |
| | | | |

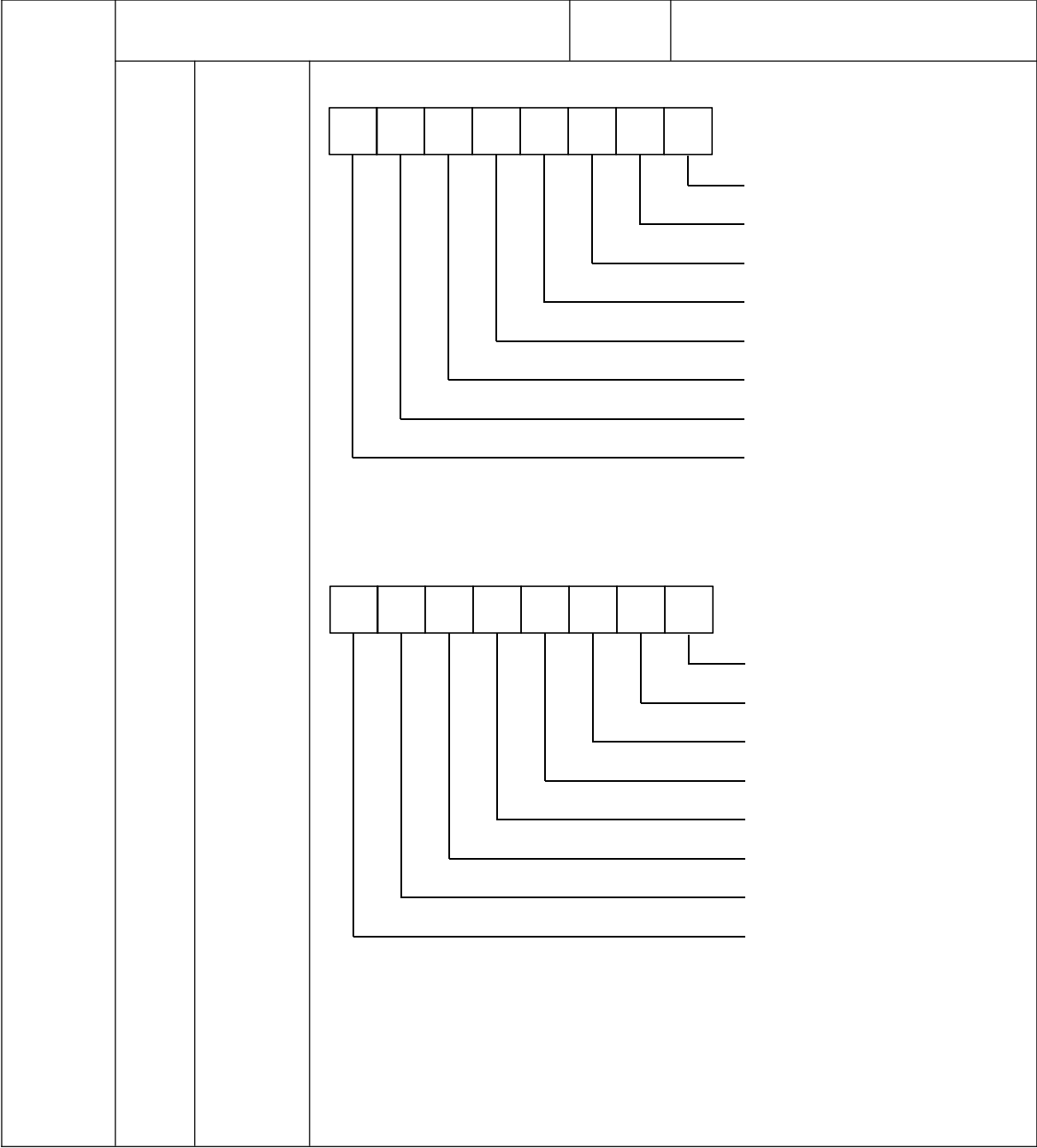

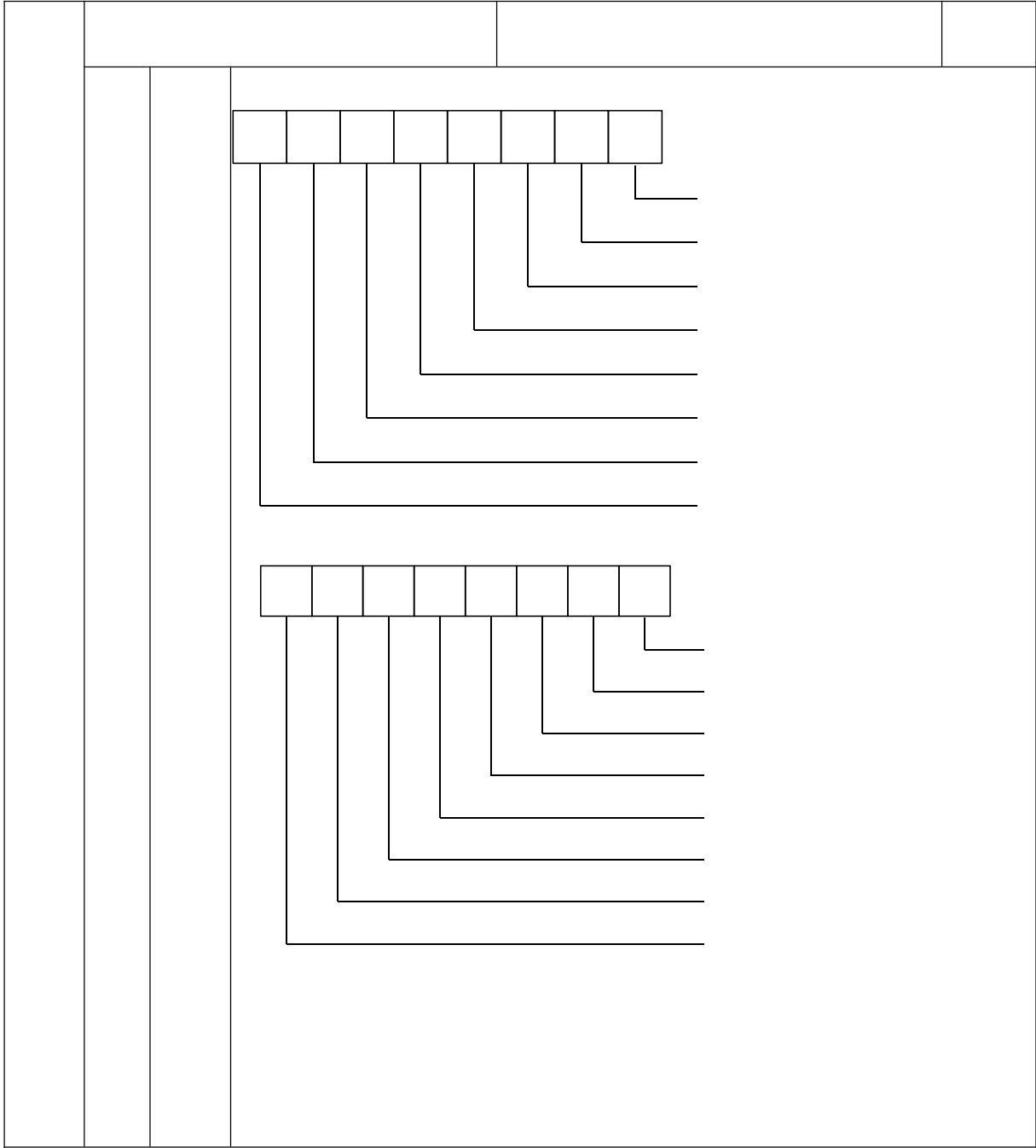

| | | | |
|--|--|--|--|
| | | | |
| | | | |





| | | | |
|--|--|--|--|
| | | | |
| | | | |
| | | | |
| | | | |
| | | | |

| | | |
|--|--|--|
| | | |
| | | |
| | | |

| | | |
|--|--|--|
| | | |
| | | |
| | | |

| | | |
|--|--|--|
| | | |
| | | |
| | | |
| | | |

| | | | |
|--|--|--|--|
| | | | |
| | | | |
| | | | |
| | | | |
| | | | |
| | | | |

| | | | |
|--|--|--|--|
| | | | |
| | | | |
| | | | |

EY



| | | |
|--|--|--|
| | | |
|--|--|--|

| | | | |
|--|--|--|--|
| | | | |
| | | | |
| | | | |
| | | | |
| | | | |
| | | | |
| | | | |
| | | | |

| | | | |
|--|--|--|--|
| | | | |
| | | | |
| | | | |
| | | | |
| | | | |
| | | | |
| | | | |
| | | | |

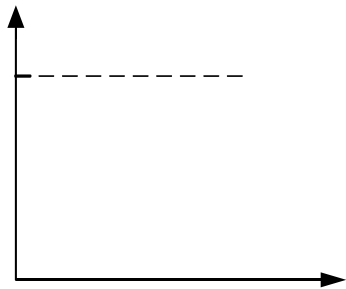

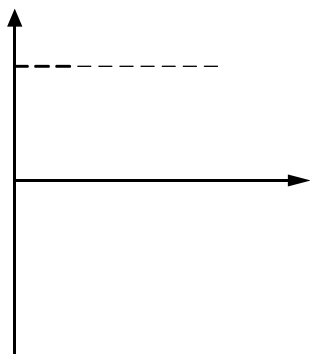

| | | |
|--|--|--|
| | | |
| | | |
| | | |
| | | |
| | | |

| | | | |
|--|--|--|--|
| | | | |
| | | | |
| | | | |
| | | | |
| | | | |
| | | | |
| | | | |
| | | | |
| | | | |
| | | | |

| | | | |
|--|--|--|--|
| | | | |
| | | | |
| | | | |
| | | | |

| | | | |
|--|--|--|--|
| | | | |
| | | | |
| | | | |
| | | | |
| | | | |

| | | | |
|--|--|--|--|
| | | | |
| | | | |
| | | | |
| | | | |
| | | | |
| | | | |

| | | | |
|--|--|--|--|
| | | | |
| | | | |

| | | | |
|--|--|--|--|
| | | | |
| | | | |
| | | | |

| | | | |
|--|--|--|--|
| | | | |
| | | | |

| | | | |
|--|--|--|--|
| | | | |
| | | | |
| | | | |
| | | | |

| | | |
|--|--|--|
| | | |
|--|--|--|

| | | | |
|--|--|--|--|
| | | | |
| | | | |
| | | | |
| | | | |
| | | | |
| | | | |
| | | | |
| | | | |
| | | | |
| | | | |
| | | | |
| | | | |
| | | | |
| | | | |
| | | | |
| | | | |
| | | | |
| | | | |
| | | | |
| | | | |
| | | | |
| | | | |
| | | | |
| | | | |
| | | | |
| | | | |
| | | | |
| | | | |

| | | | |
|--|--|--|--|
| | | | |
| | | | |
| | | | |
| | | | |

| | | | |
|--|--|--|--|
| | | | |
| | | | |
| | | | |
| | | | |
| | | | |
| | | | |
| | | | |
| | | | |
| | | | |
| | | | |
| | | | |
| | | | |
| | | | |
| | | | |
| | | | |



GUIDE

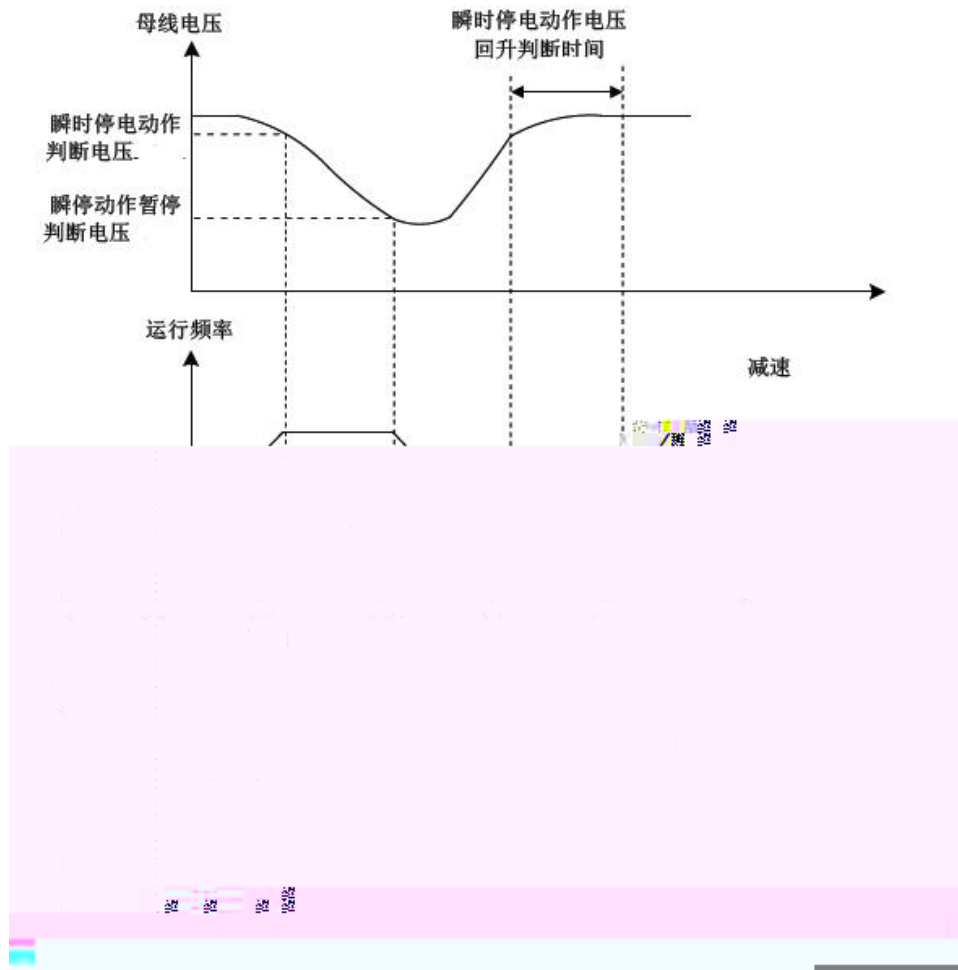

| | | | |
|--|--|--|--|
| | | | |
| | | | |
| | | | |
| | | | |
| | | | |
| | | | |

| | | | |
|--|--|--|--|
| | | | |
| | | | |
| | | | |
| | | | |

| | | | |
|--|--|--|--|
| | | | |
| | | | |
| | | | |
| | | | |

| | | | |
|--|--|--|--|
| | | | |
| | | | |
| | | | |
| | | | |

| | | | |
|--|--|--|--|
| | | | |
| | | | |

频率源选择

频率源叠加选择

频率源切换设置

目标运行频率

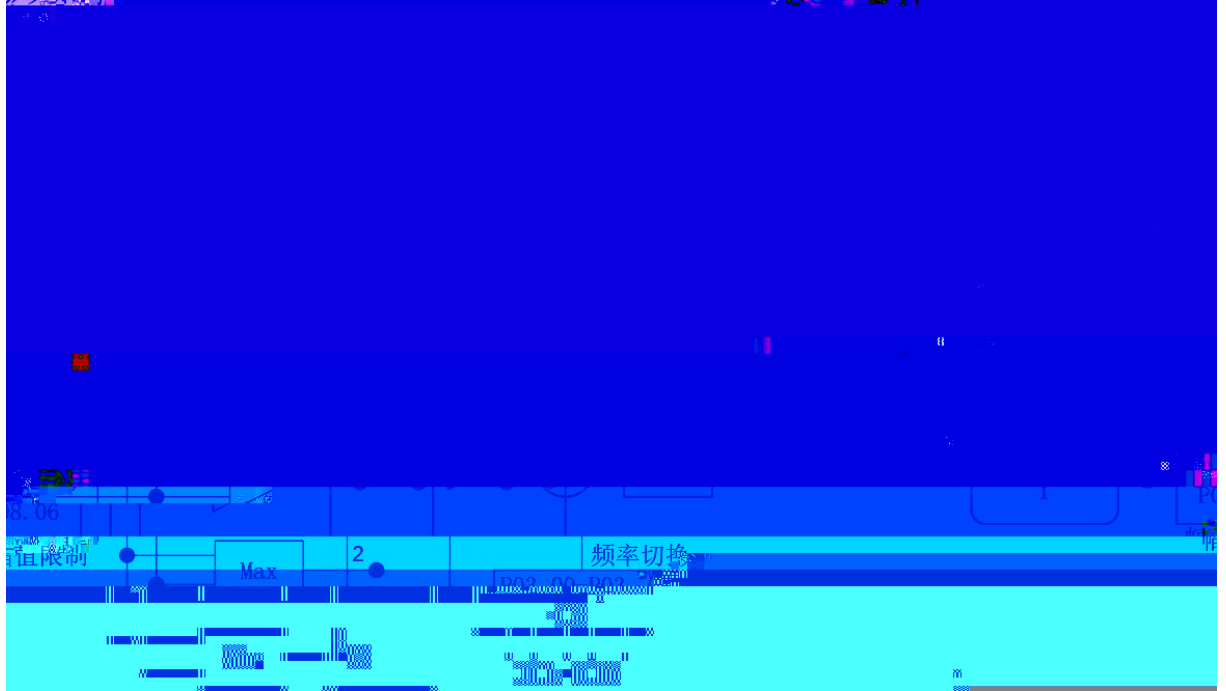

| | | | |
|--|--|--|--|
| | | | |
| | | | |

| | | | | |
|--|--|--|--|--|
| | | | | |
| | | | | |
| | | | | |

| | | | |
|--|--|--|--|
| | | | |
| | | | |

| | | | | |
|--|--|--|--|--|
| | | | | |
| | | | | |
| | | | | |
| | | | | |
| | | | | |
| | | | | |
| | | | | |



| | | | |
|--|--|--|--|
| | | | |
| | | | |

| | | | |
|--|--|--|--|
| | | | |
| | | | |
| | | | |
| | | | |

| | | | |
|--|--|--|--|
| | | | |
| | | | |

| | | | | |
|--|--|--|--|--|
| | | | | |
| | | | | |
| | | | | |
| | | | | |
| | | | | |

| | | | |
|--|--|--|--|
| | | | |
| | | | |
| | | | |
| | | | |

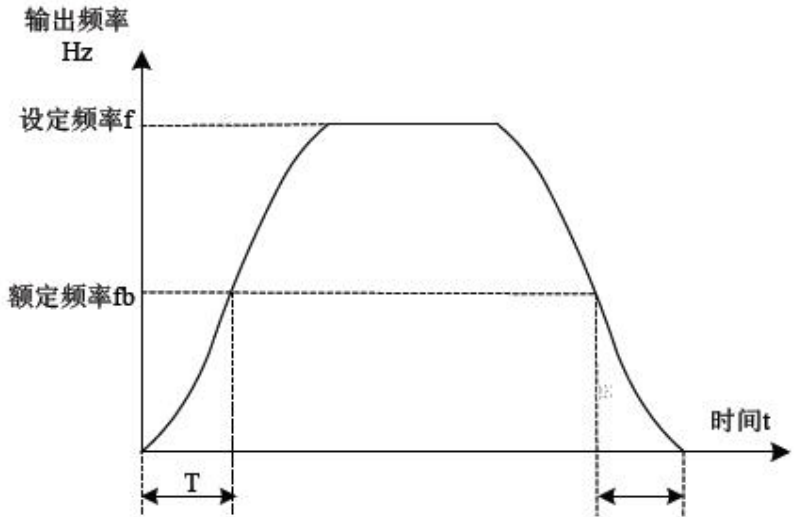
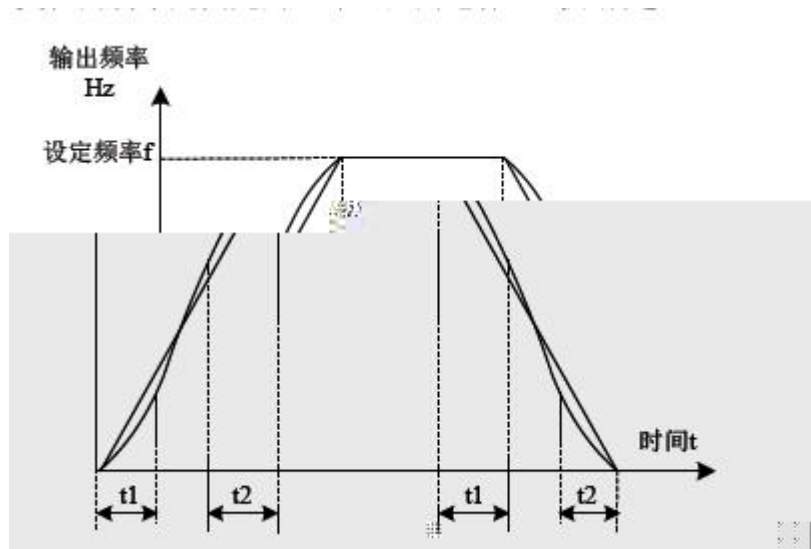

| | | | |
|--|--|--|--|
| | | | |
| | | | |
| | | | |

变频器应用案例

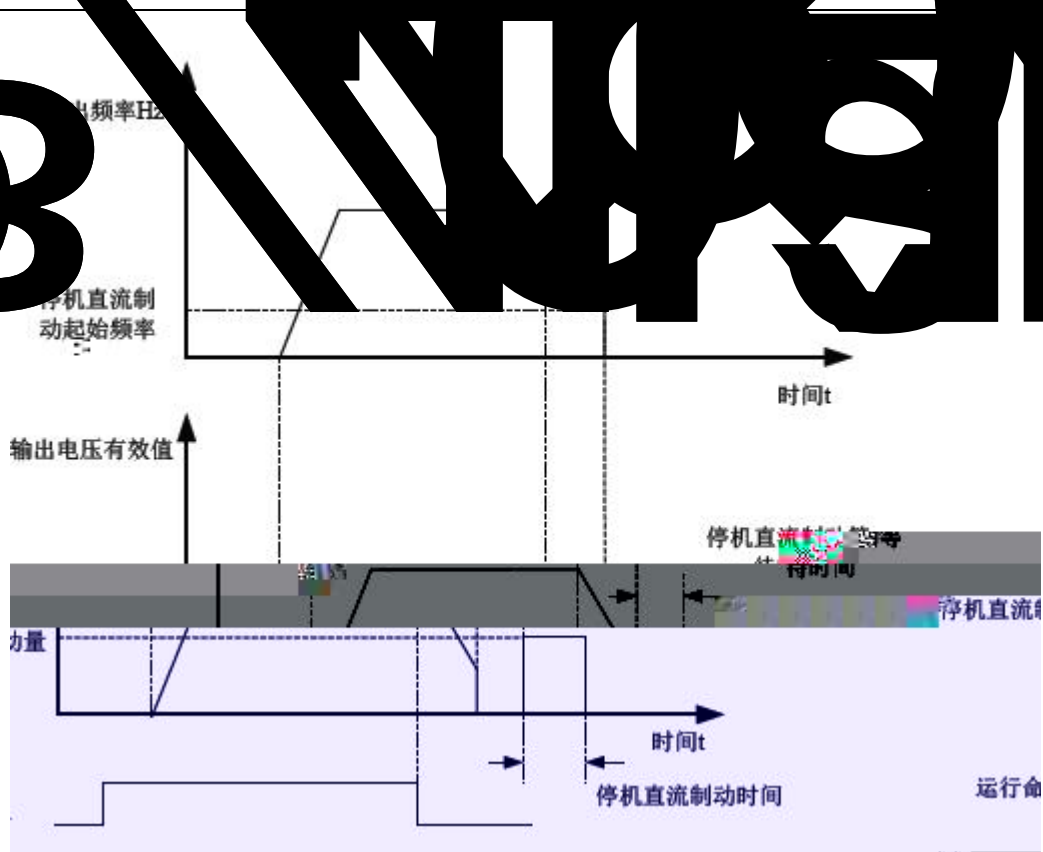

| | | | |
|--|--|--|--|
| | | | |
| | | | |

变频器应用案例 | 变频器应用案例 | 变频器应用案例 | 变频器应用案例

| | | | |
|--|--|--|--|
| | | | |
| | | | |
| | | | |
| | | | |

| | | | |
|--|--|--|--|
| | | | |
| | | | |
| | | | |
| | | | |
| | | | |
| | | | |

| | | | |
|--|--|--|--|
| | | | |
| | | | |
| | | | |
| | | | |

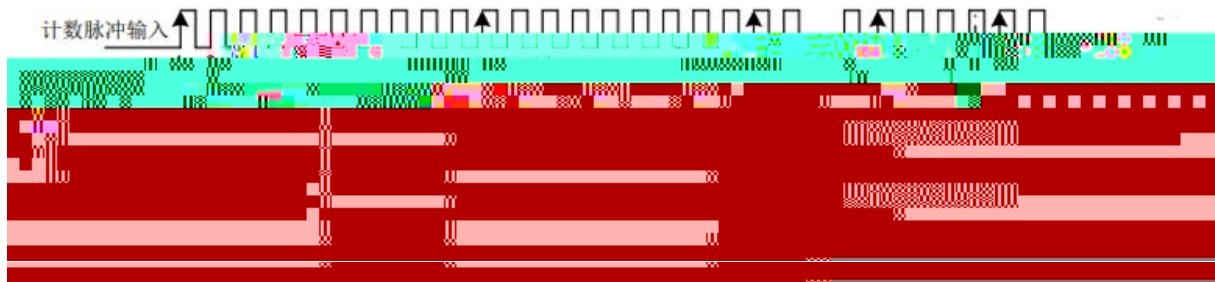

| | | | |
|--|--|--|--|
| | | | |
| | | | |
| | | | |
| | | | |
| | | | |
| | | | |
| | | | |
| | | | |
| | | | |
| | | | |

| | | | |
|--|--|--|--|
| | | | |
| | | | |
| | | | |
| | | | |
| | | | |
| | | | |
| | | | |
| | | | |

C

| | | | |
|--|--|--|--|
| | | | |
| | | | |

| | | | |
|--|--|--|--|
| | | | |
| | | | |

| | | | |
|--|--|--|--|
| | | | |
| | | | |
| | | | |
| | | | |
| | | | |
| | | | |
| | | | |
| | | | |
| | | | |
| | | | |

| | | | |
|--|--|--|--|
| | | | |
| | | | |
| | | | |
| | | | |

03

12 14 16 18 20 22 24 26 28 30 32 34 36 38 40 42 44 46 48 50 52 54 56 58 60 62 64 66 68 70 72 74 76 78 80 82 84 86 88 90 92 94 96 98 100

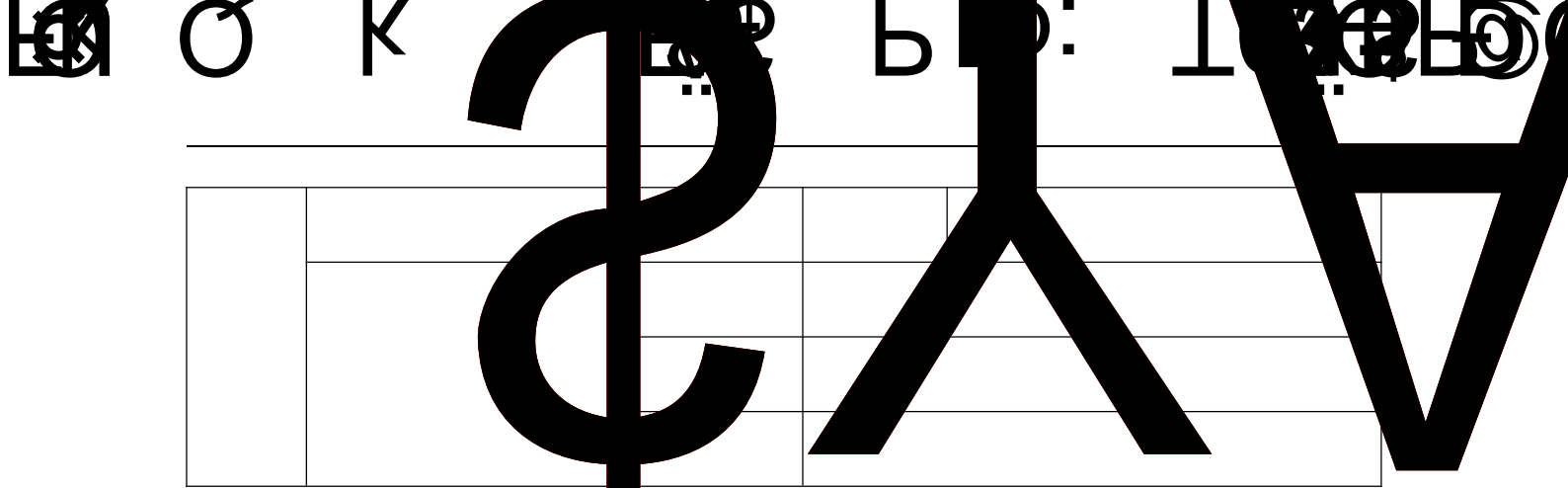

02100AISA <

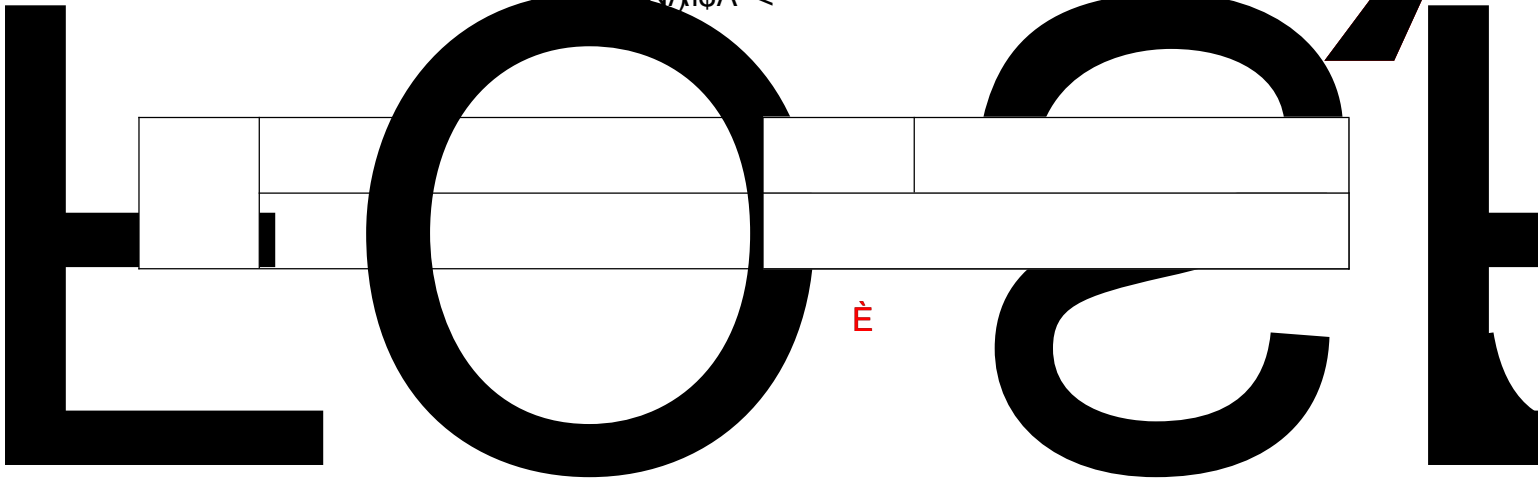

É

3

M0r

· \$YÀ

h

| | | | |
|--|--|--|--|
| | | | |
| | | | |

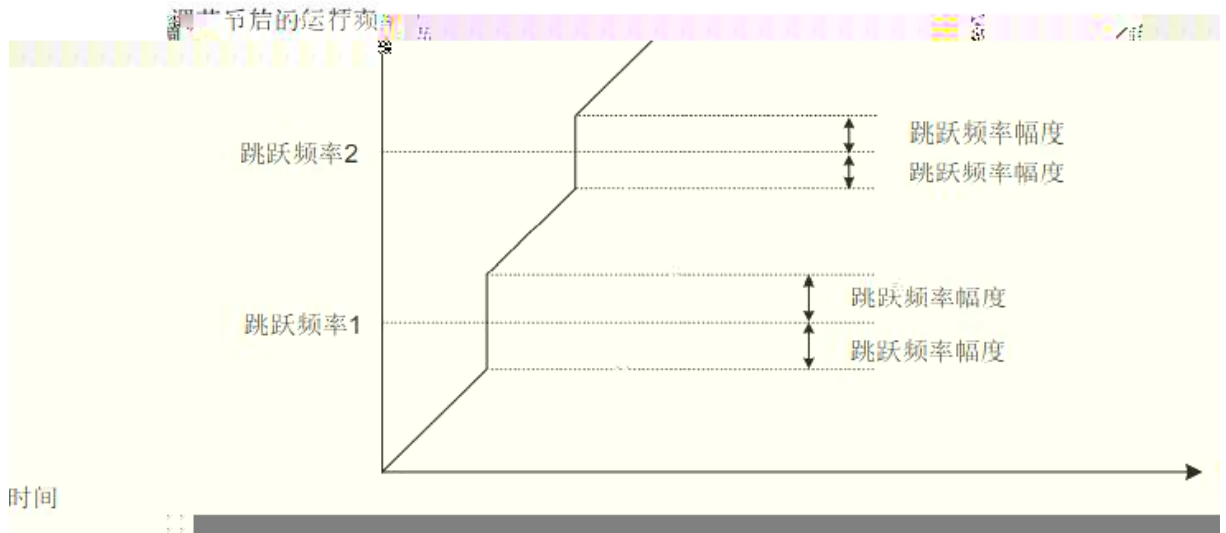

| | | | |
|--|--|--|--|
| | | | |
| | | | |
| | | | |
| | | | |

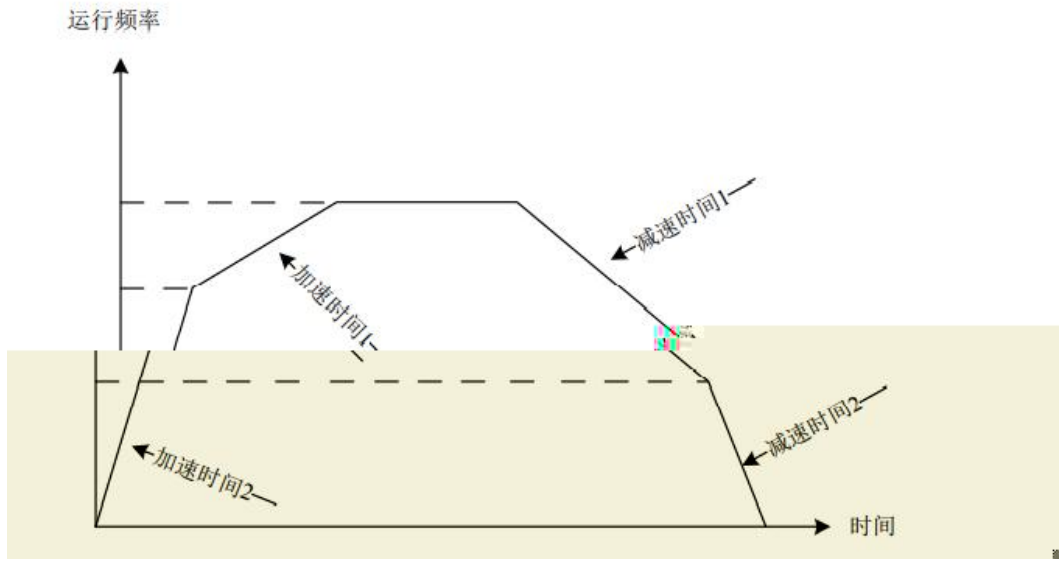

| | | | |
|--|--|--|--|
| | | | |
| | | | |
| | | | |
| | | | |
| | | | |
| | | | |
| | | | |
| | | | |
| | | | |
| | | | |
| | | | |
| | | | |
| | | | |
| | | | |
| | | | |
| | | | |
| | | | |
| | | | |

| |
|--|
| |
| |
| |
| |



GF630N01

1. 01

Wuhan Guide Technology Co., Ltd.