

HF680NLC

690V

1.00

Wuhan GUIDE Technology Co., Ltd

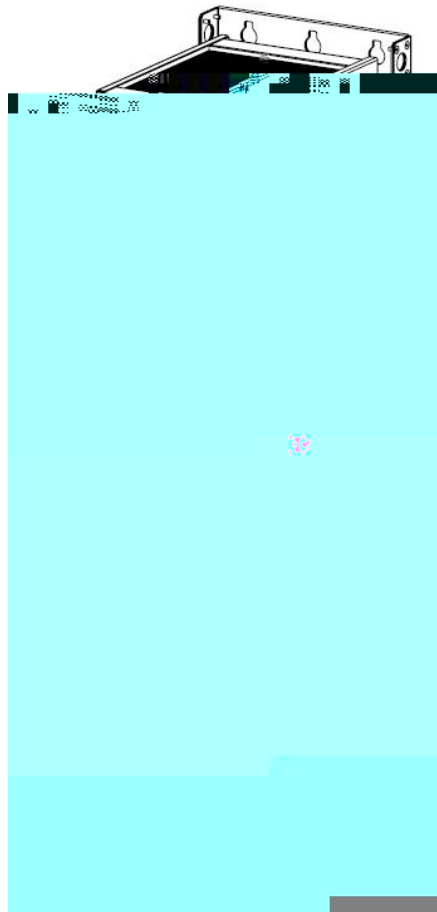

RTG



- 1
- 1.1
- 1.2
- 1.3
- 1.3.1
- 1.4
- 1.5
- 1.6
- 2
- 2.1
- 2.2
- 2.3
- 2.4
- 2.4.1
- 2.4.2
- 3
- 3.1
- 3.2
- 3.2.1



y

1 q

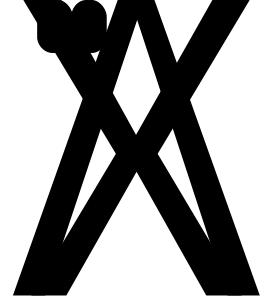

- 10
- 10
- 12
- 13
- 13
- 14
- 15
- 15
- 16
- 16
- 16
- 17
- 18
- 18
- 18
- 18
- 19
- 19
- 21
- 5



8.2		49
8.3		49
8.4	50
8.5	50

1

2

3 " " " " " "

4



10

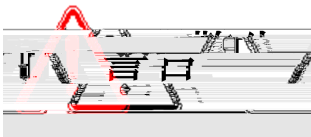
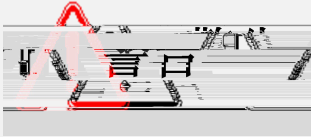



3

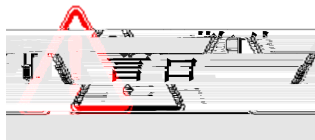
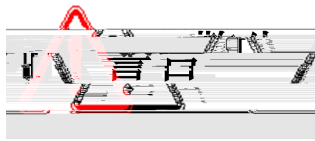

IEC



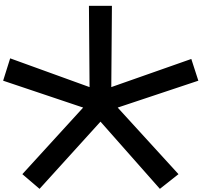
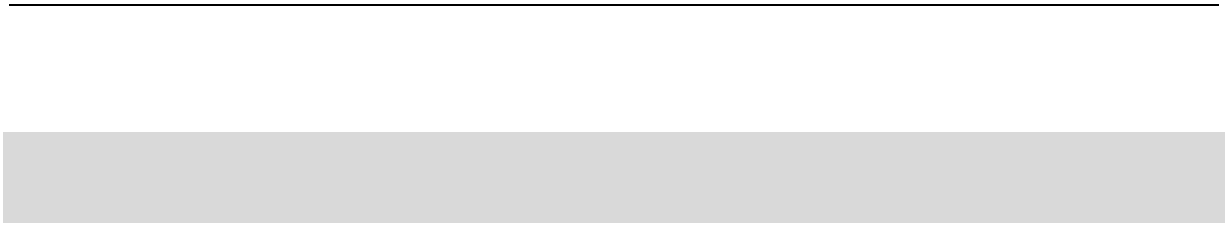

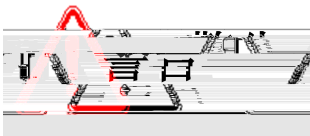
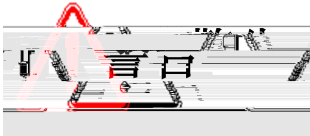
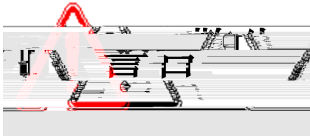

Q

1

RCM
RCM

B

RCD

RCD
RCD

RCD

RCD

RCD

2

3

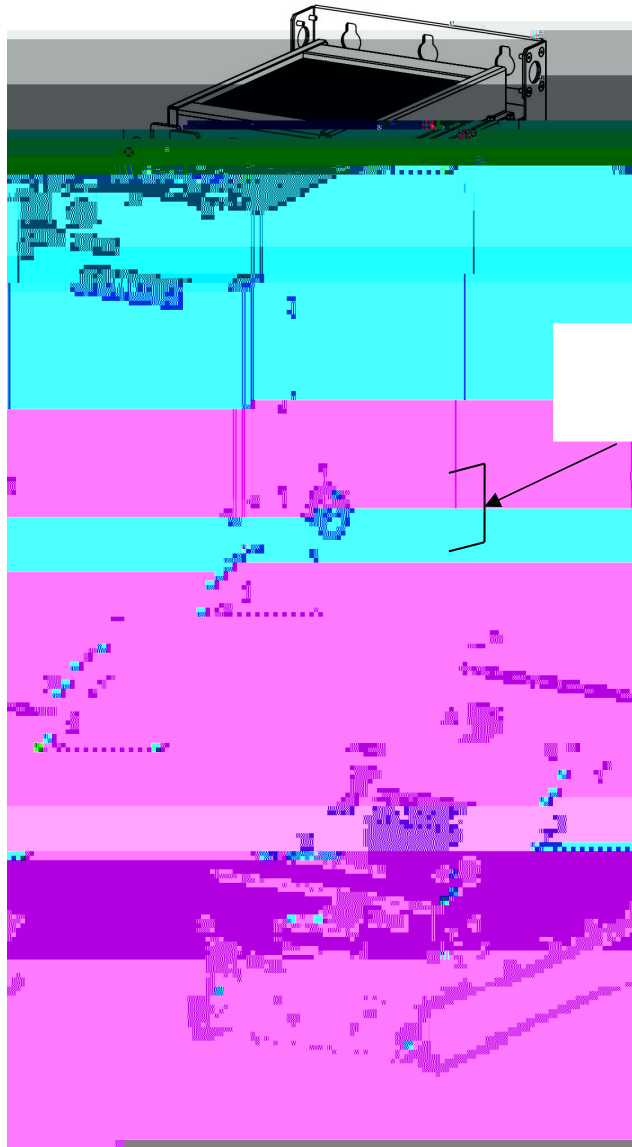

HF680NLC04M1935-6

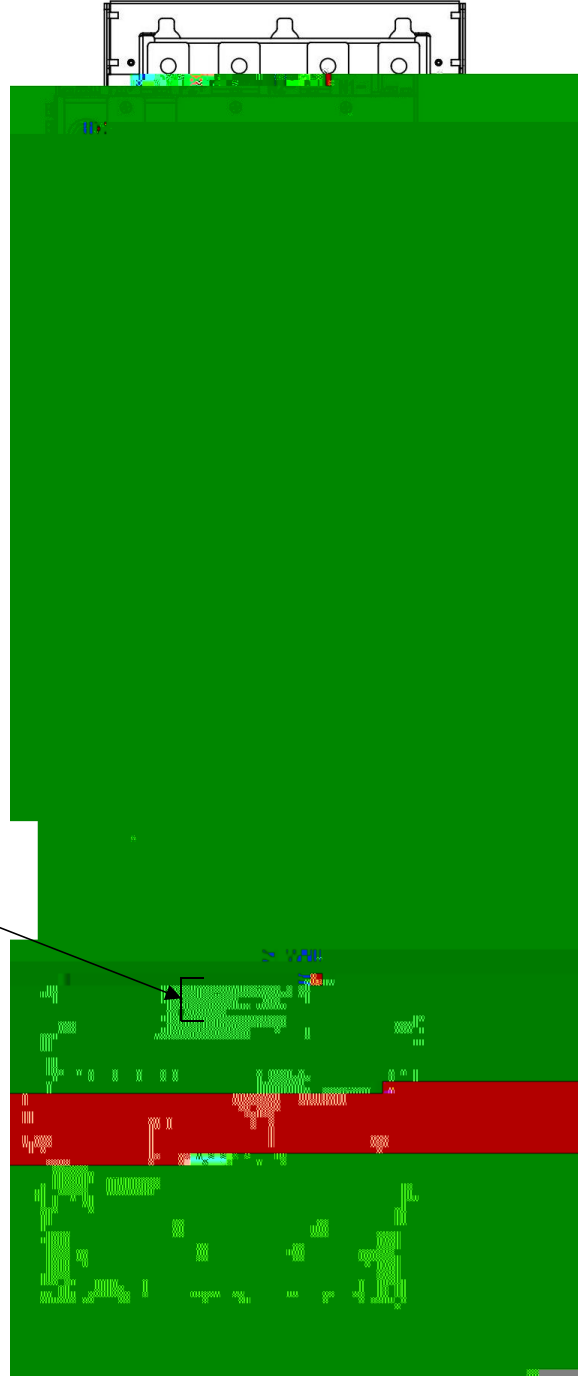

HF680NLC04M1935-6

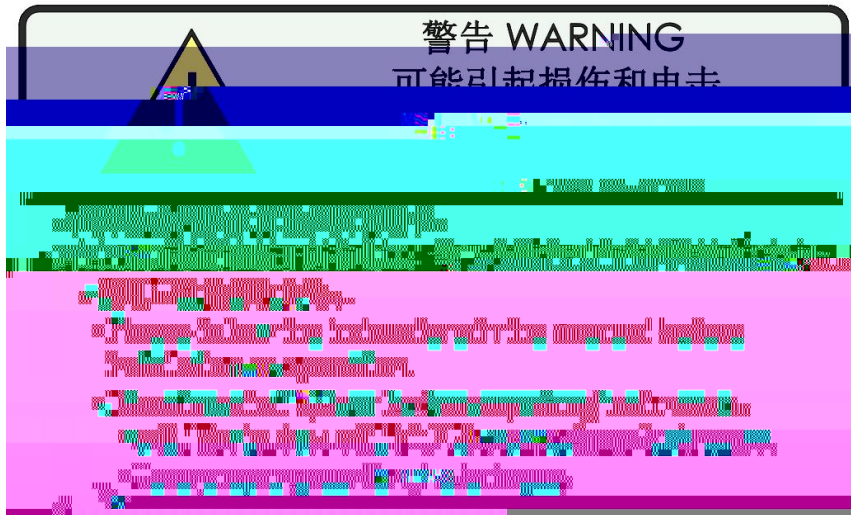

1.2

(1)

(SCR: Si I i con Control I ed Recti fl er)

(2)

(3)

(4)

LVD	2014/35/EU	EN 61800-5-1
EMC	2014/30/EU	EN 61800-3

1.3

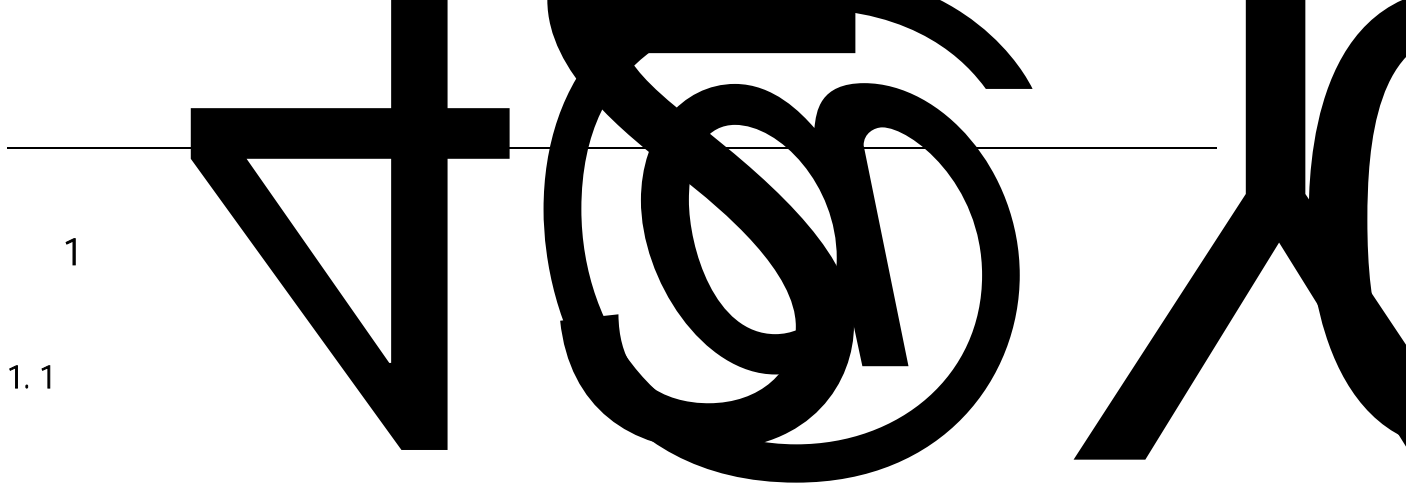

1
1.1

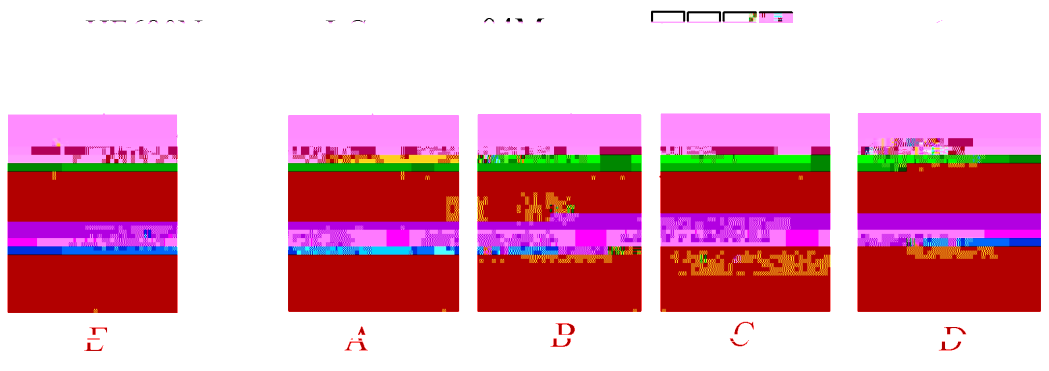

A HF680N
B - m'

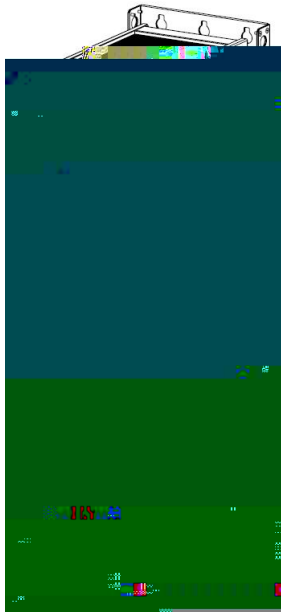

型号: HF680NLC04M-1935-6

额定功率: 1935kW 额定电压: 5V-690V 50/60Hz 额定电流: 1706A

输入: AC3PH 525V 输出: DC 742-900V

E-STAND:V1.00

Product ID.

8888888A8A088

MADE IN CHINA

	A AC	A DC	KW	KVA	A DC	A DC	
HF680NLC04M1233-6	1143	1400	1233	1370	1344	1120	P1
HF680NLC04M1935-6	1796	2200	1935	2150	2112	1760	

1 1935kW

2

3

4

LCD

LCD

NB01

GDHF-AMBX1

GDHF-AMBX1

MODBUS-RTU

RS485

PN	GDHF-APNX1	GDHF-APNX1 HF680NLC04M	Profi net	RJ 45
	GDHF-AKZY1	GDHF-AKZY1	LCD	
2	2.8*8.8 2	2.8*8.8 2		HF680NLC04M

1 HF680NLC01M1233-6+PN01 690V/1233kW

Profi net

1.2

HF680NLC04M

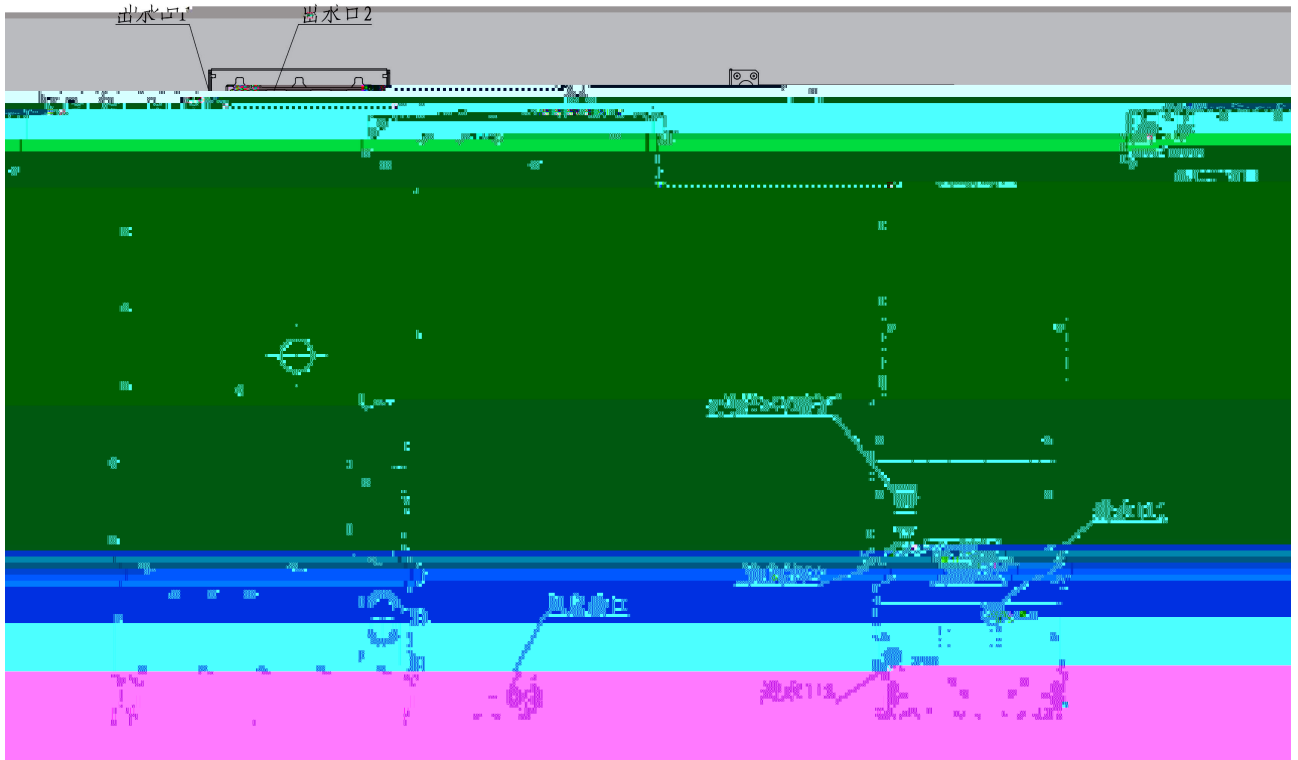

	+24V	Ø3.2	
1	1	KFG2H1613-03	SMC

1	1	T1613W	SMC	
2	2	KFG2H1209-03	SMC	
2	2	T1209W	SMC	

1.3

1.3.1

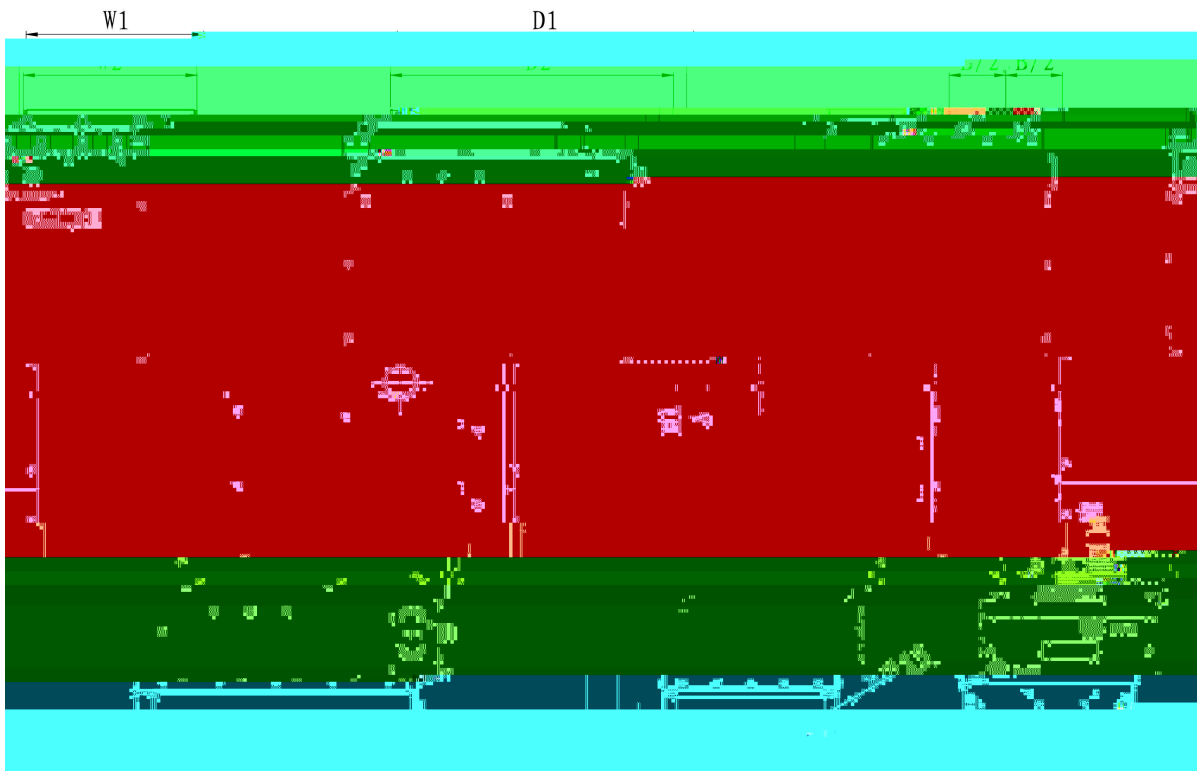

	mm					mm			8.8	kg
	H1	W1	V2	D1	D2	A	B			
HF680NLC03C-1233-6	110 0	320	307	525	500	1064	200	6- 13	6-M2	260
HF680NLC03C-1935-6										

1. 4



2 3

2.4

2.4.1

	A	/ mm ²	A	A
HF680NLC04M1233-6	1250	500*2	1250	1800
HF680NLC04M1935-6	2000	630*2	2000	3000

2.4.2

mm² AVG

* L1 mm L2 mm d mm D mm

3

1.

/

"

"



/

2

30 ð

~~RECIBO DE DEPÓSITO EN CASH (" ° ñ @ ñ ð % i~~



	-10 +40 40 1 1% 50 -10	-20 +60 1 /	-20 +60
	70 106 kPa 0.7 1.05	70 106 kPa 0.7 1.05	60 106 kPa 0.6 1.05
	10Hz f 57Hz 0.075mm 57Hz f 150Hz 9.8 m/s ²	10Hz f 57Hz 0.075mm 57Hz f 150Hz m/s ² 9.8	
		100m/s ² 11ms	100m/s ² 11ms
		250mm <100kg 100mm 100kg	250mm <100kg 100mm 100kg
	95%RH		
	1000	1000 3000	100 1%
	2		

3.2

3.2.1

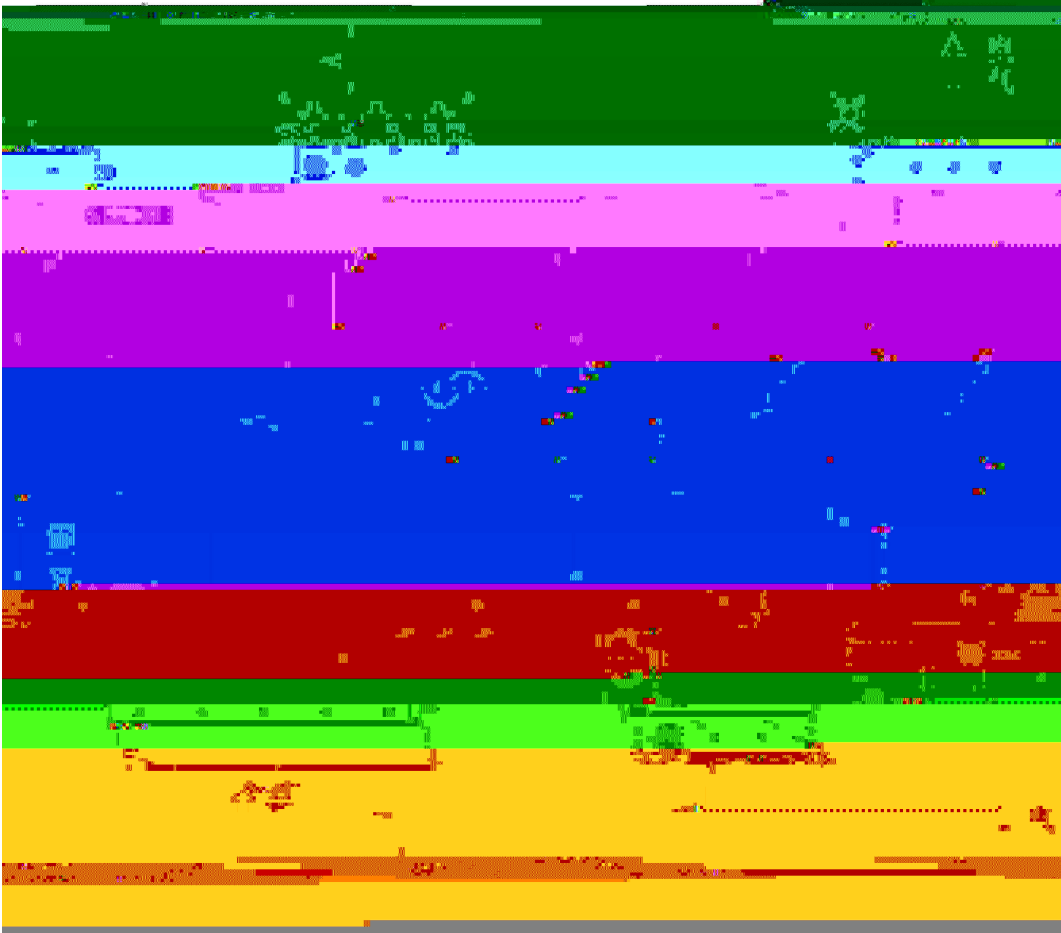

	A 250mm

50mm

3.2.2

1

2



HF680NLC04M 1935- 6

3.2.3

4

2

2

1

4

3

4

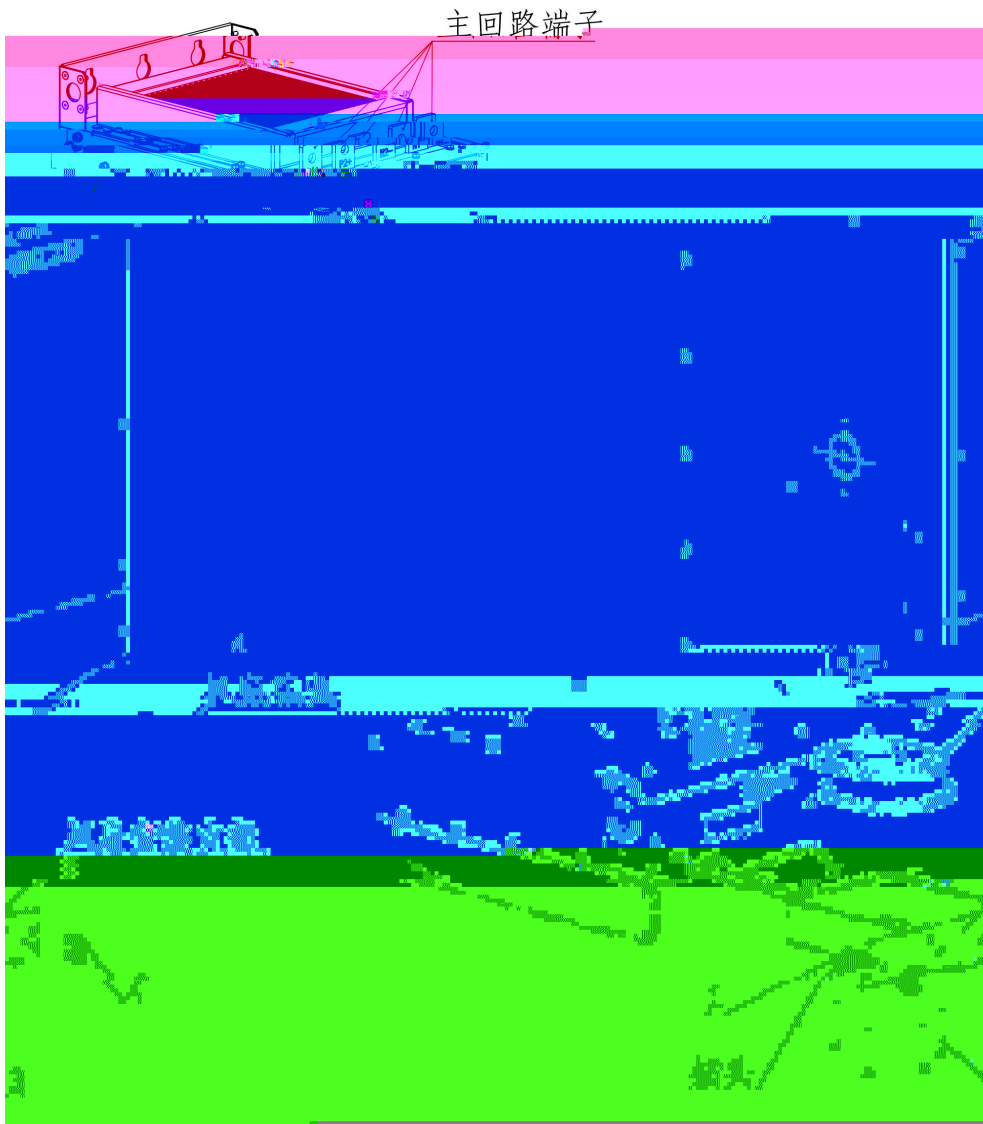

HF680NLC04M1935-6

3.3

3.3.1

6

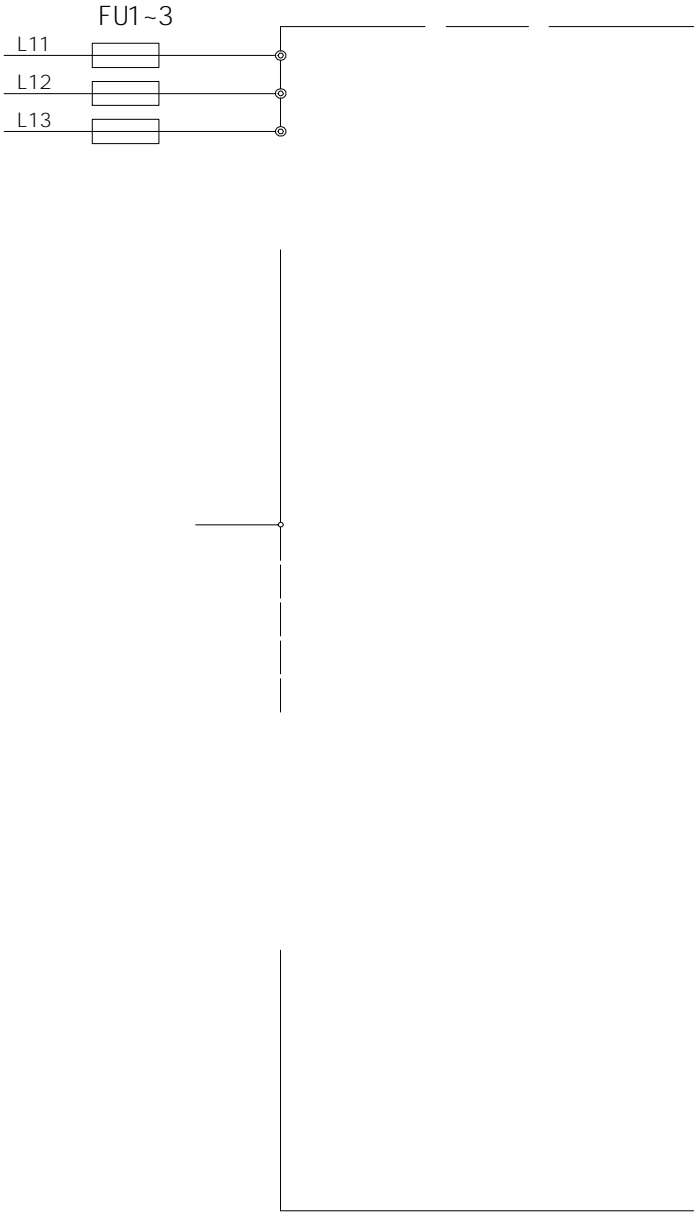

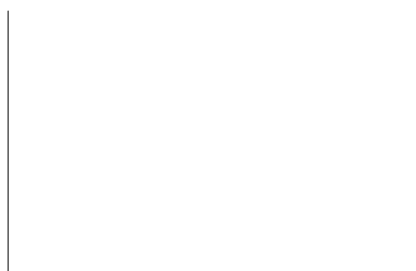
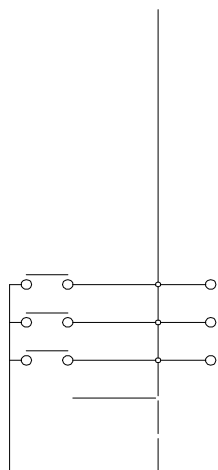
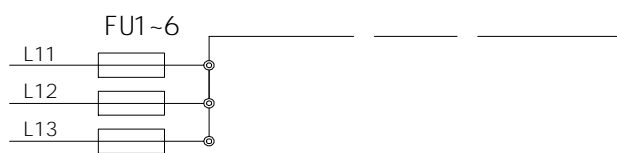

3.3.2

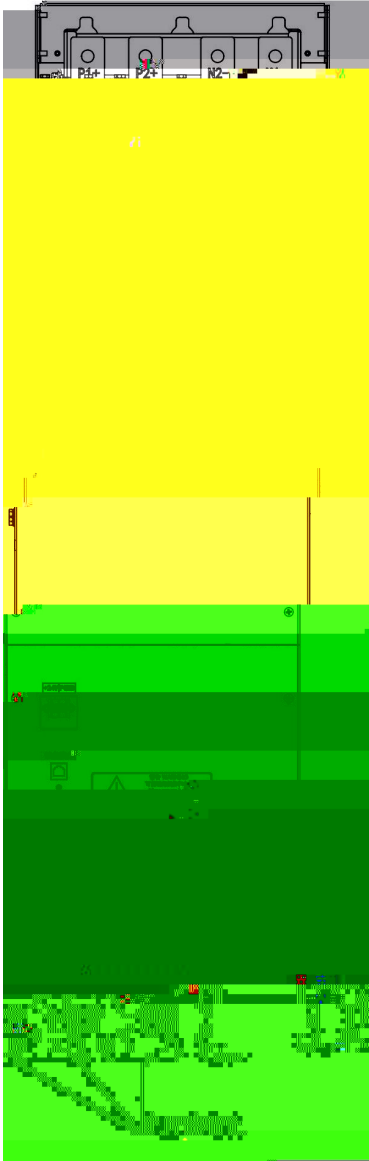

P1+ P2+	
N1- N2-	
R1 R2 S1 S2 T1 T2	
PE	

3.3.3

1		
2	10	
3		
4	10cm	
5	50m	O. 75mm ²
6		10cm
7		
8		

3.3.4

	+10V- GND	10V	+10V 50mA 1k -5k
	+24V- COM	24V	+24V 200mA
	PW		24V DI 1-DI 5 DO1 PW 24V
	AI 1- GND	1	DC - 10V~10V 100k
	AI 2- GND	2	- 10VDC~10VDC/0mA~20mA J1



DI 1- PW

1

500

100k

9V~30V DI 1-DI 4

3. 3k



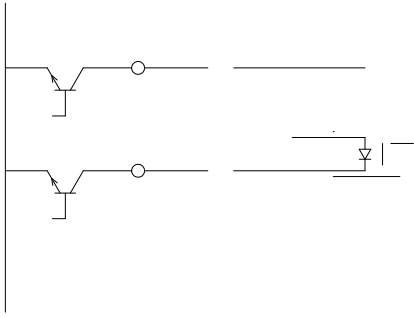

4

HF680NLC04M

F1

LOCAL/REMOTE

F2

RUN

STOP

/RESET

ENTER



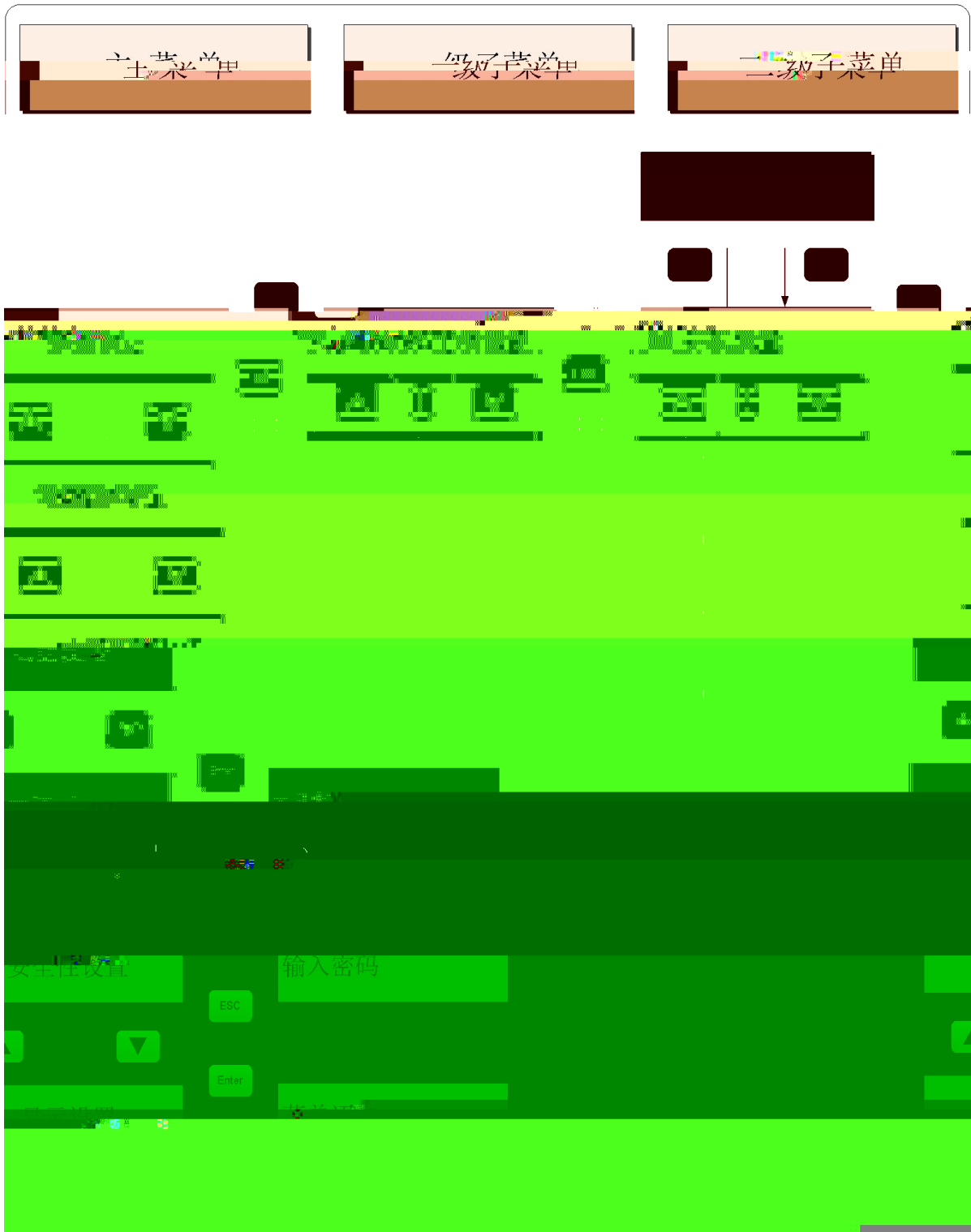

4.3

1 Drive Monitor

(I/O)

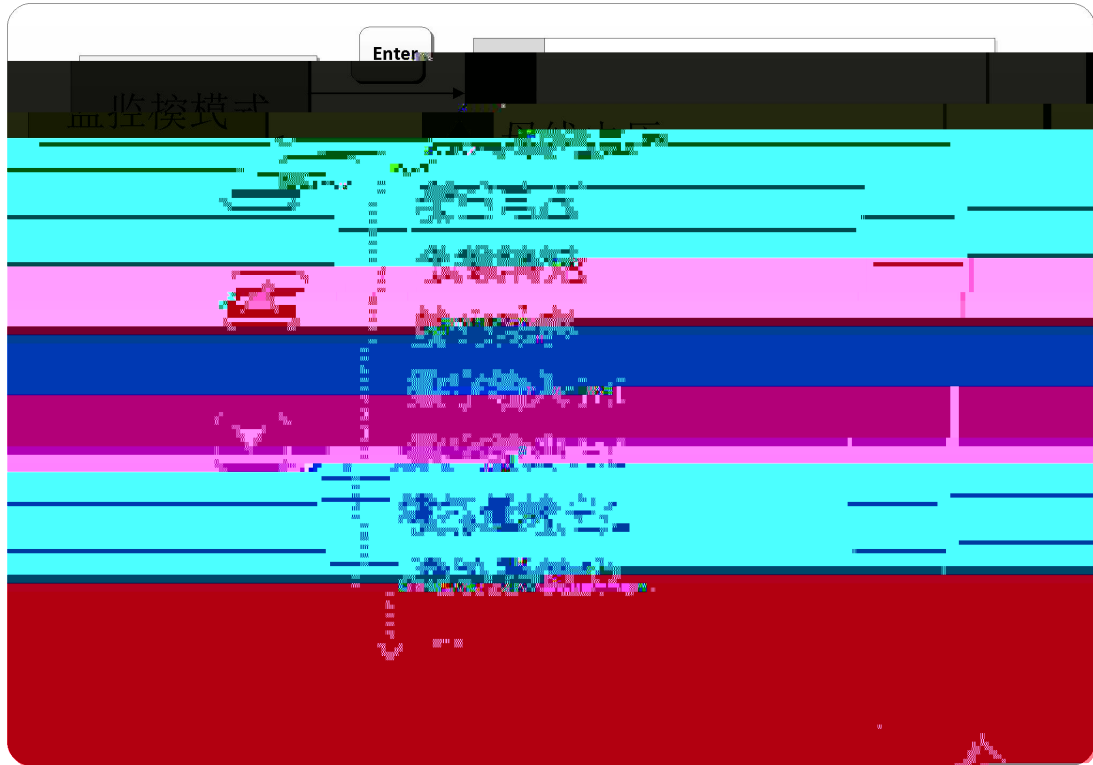

		V	
		V	
		kW	
	HL		
	HL		
	1	%	1
	2	%	2
	1	V	1
	1	A	1
	2	V	2
	2	A	2
		V	
A		A	A
B		A	B
C		A	C
		A	

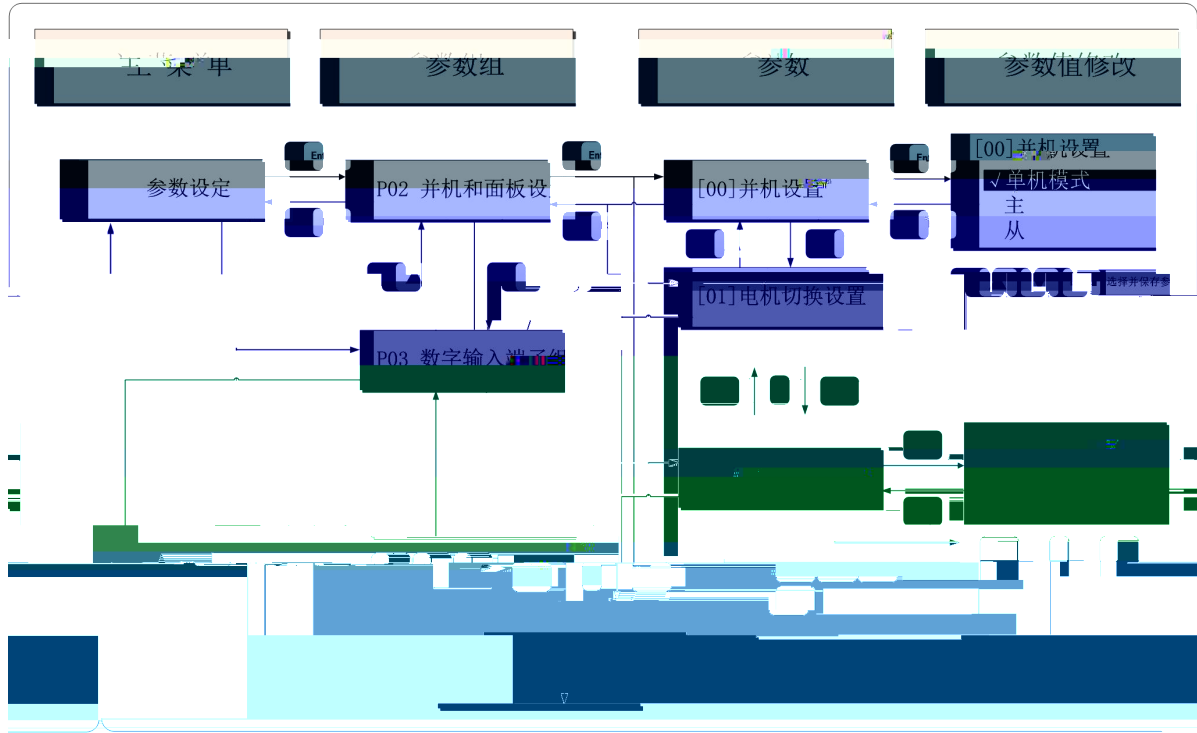

Function Set

Function Set		



" Enter "

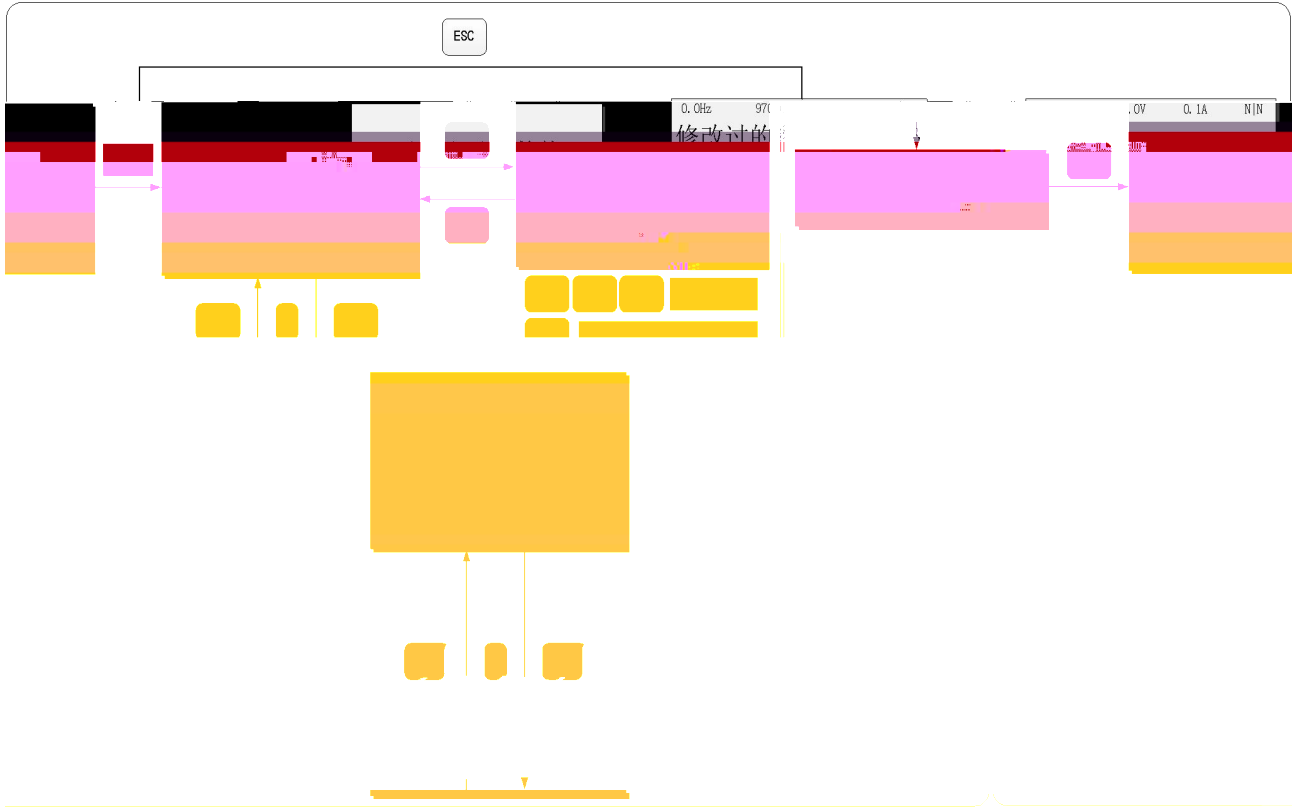

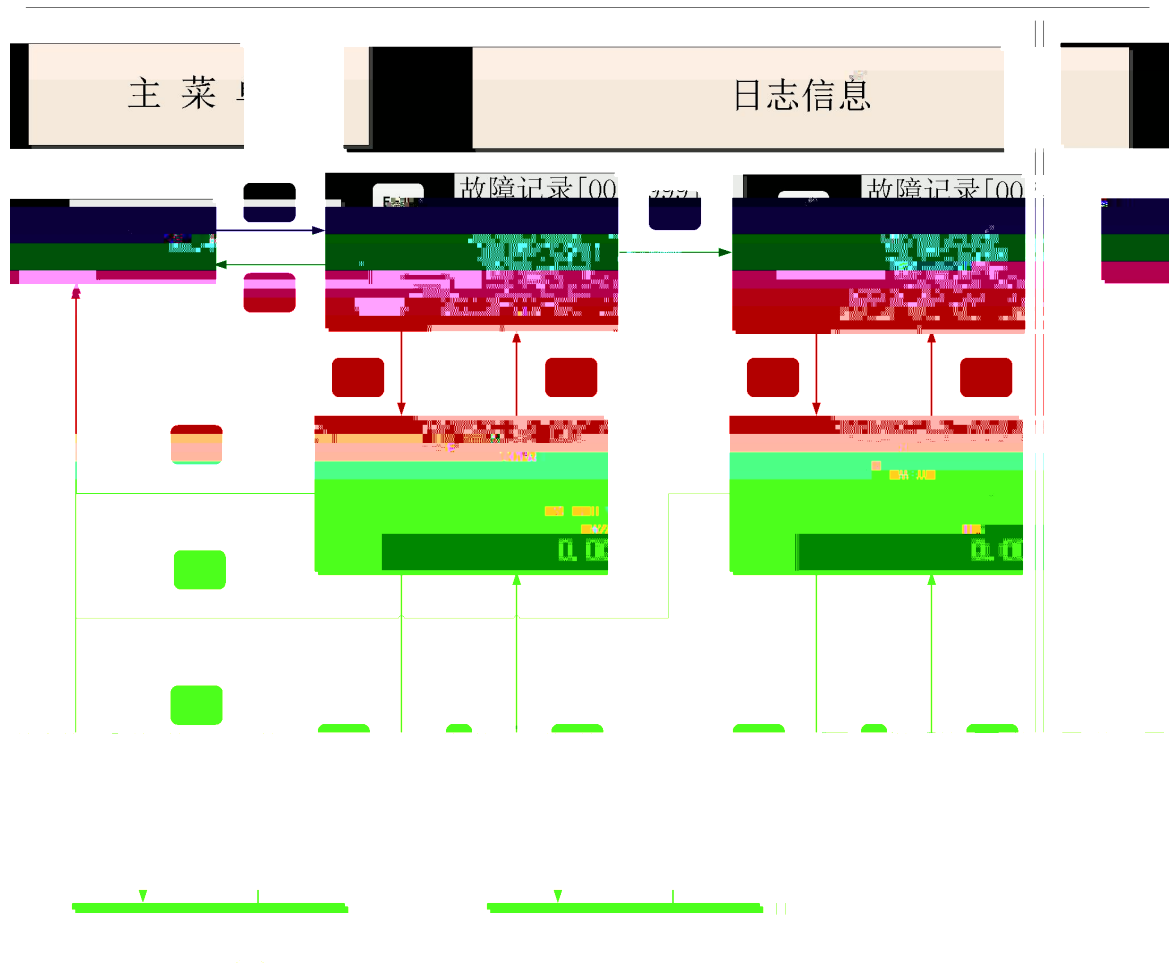

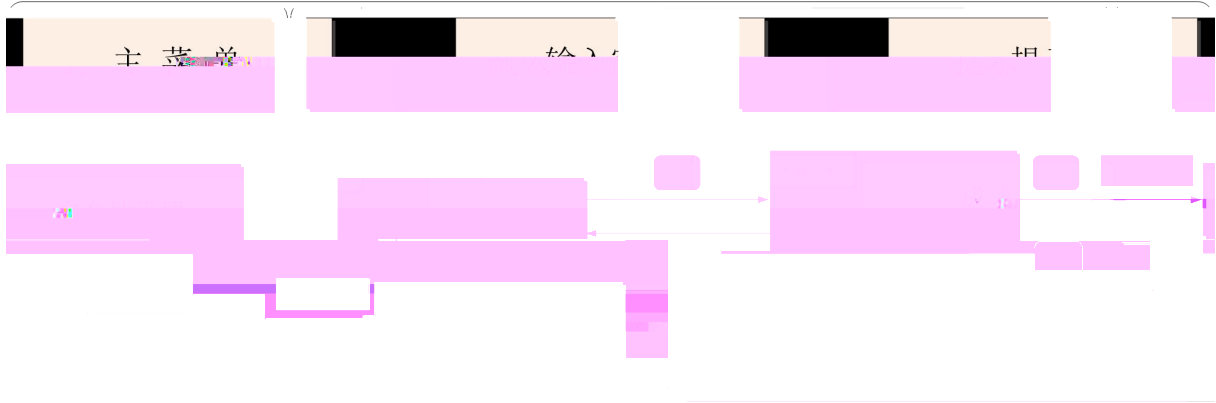



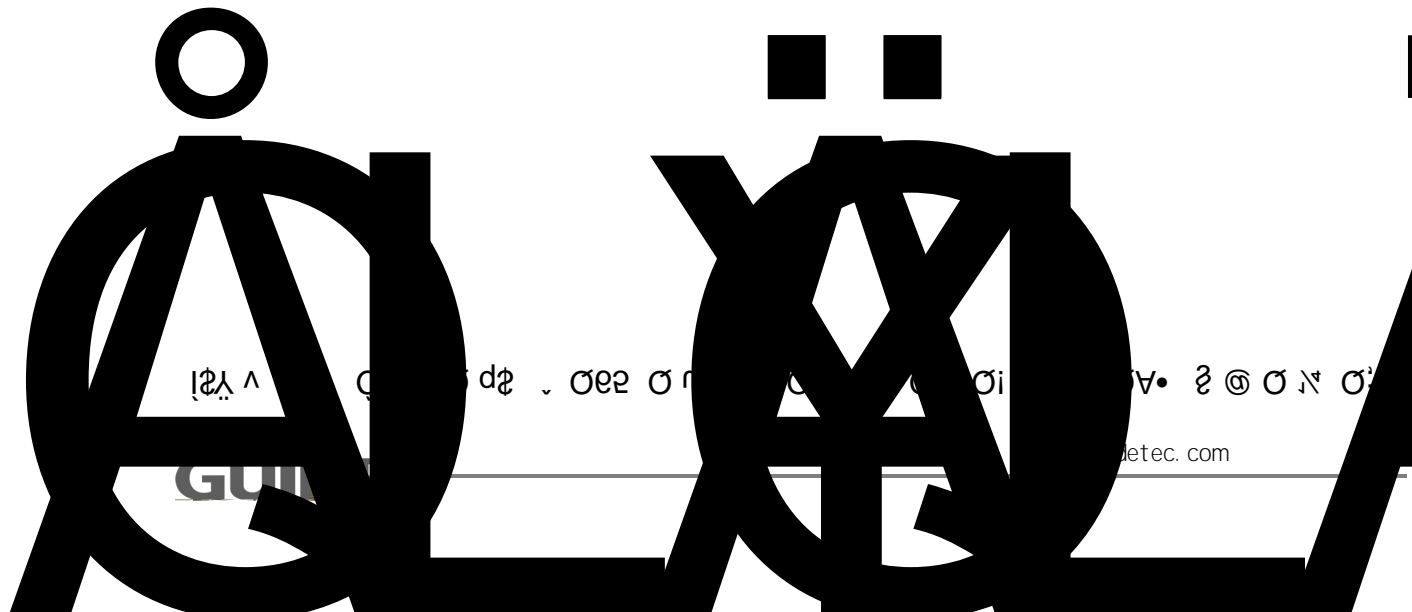

5

5.1

DI 1

DI 2

DO5

1

690V

24V

P0. 1

"

"

"

"

690V

P3. 0	1	
P3. 1	5	
P4. 3 DO4	1	
P4. 4 DO5	2	
P16. 11	5	
P16. 12	10	
P16. 0		
P24. 4	0	

24V

690V

"

AFE "

"

AFE "

49. 5~50. 5Hz

DI 1

*1. 41

*1. 41

P24. 4

1

6

6.1

6.1.1

P3.0	1		0 32	1	
P3.1	2		0 32	2	
P3.2	3		0 32	5	
P3.3	4		0 32	6	
P3.4	5		0 32	7	
P3.5	6		0 32	8	
P3.6	7		0 32	0	
P3.7	8		0 32	0	

0		
1		
5		</RST
14		
15	. NC	

6.1.2

P4.0	1	0	64	0
P4.1	2	0	64	0
P4.2	3	0	64	0
P4.3	4	0	64	0
P4.4	5			

P7.50	2	2	0.0 300.0 [%]	200.0 [%]	
P7.51	2	2	0.00 5.00 [s]	5.00 [s]	
P7.95			0.0 20.0 [s]	15.00 [s]	

6.1.4

P8.0		[0] [1] [2] DP [3] MODBUS [4]	0 4	0	

6.1.5

P16.0			580 800 [V]	690 [V]	
P16.2			0.0 4000.0 [kW]	[kW]	
P16.4			0.0 6500.0 [A]	[A]	
P16.11		5	0 5	0	[5]
P16.12		10K	1~15	10	10K

V01	SYS_NOT_RDY	(Ready)	
V02	NO_DRV_ENABLE]	P3
V03	LOCAL_EM]	P3
V04	REMOTE_EM]	P3
V06	Q.T)	P7.14(
V09	DP P/B ALARM	DP	DP

7.1

[E100]	OV	P7.12()
[E110]	OC	
[E139]	Pre_Charging Fail	P7.95 P16.0
[E140]	Line UV	P16.0
[E141]	Line OPEN	
[E145]	Line OV	P16.0
[E146]		

5

1/4

8



1

2

3

4



1

CMOS

2

3

8.1

8.2

1.
2.

1. > 40
2. < 95%

1.
2.

1.
2.

Αμ

d . . . ε

5

h ω

2

8.4

5

1 40

2 80%

3 24 /

8.5

1

2

5

HF680NLC

690V

1.00

- 1
- 2
- 3

Wuhan Guide Technology Co., Ltd.

6

430223

86-027-87927230

shfw@guidec.com

www.guidec.com

400-0077-570

†

8y@-u

O